

DOGHER

Making Solutions [®] TOOLS



PROMOCIÓN

20²³
24

CALIDAD INDUSTRIAL
MÁXIMO RENDIMIENTO



PRECIOS RECOMENDADOS
IVA NO INCLUIDO
VÁLIDO PARA PENÍNSULA Y BALEARES



MESA METÁLICA DE TRABAJO 2 CAJONES Y PANEL VERTICAL PORTAHERRAMIENTAS

- Panel Vertical Portaherramientas
- 2 Cajones de Alta Capacidad

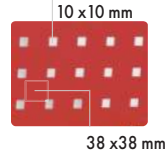

Carga Total: 900 kg
Mesa: 1500 x 640 x 1550 mm
Panel: 1500 x 730 mm

Ref 027-004

~~1.327,47 €~~ 761,34 €

MESA METÁLICA DE TRABAJO 3 CAJONES

- 3 Cajones de Alta Capacidad

Carga Total: 500 kg
Mesa: 2000 x 640 x 865 mm



Ref 027-001

~~1.280,58 €~~ 753,28 €

TORNILLOS DE BANCO GUÍA REDONDA

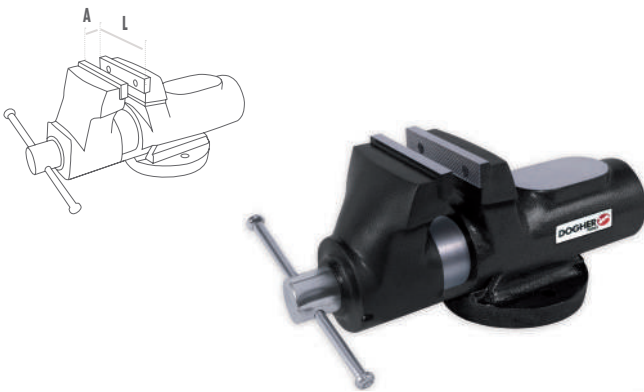

L mm	A mm	Kg	Ref	Price	Price
▶ 100	105	13	925-100	339,42 €	199,68 €
125	130	22	925-125	467,36 €	274,91 €
150	165	32	925-150	667,33 €	392,54 € ▶

• Base giratoria ver pag. 493 de Cat. general

TORNILLOS DE BANCO GUÍA CUADRADA

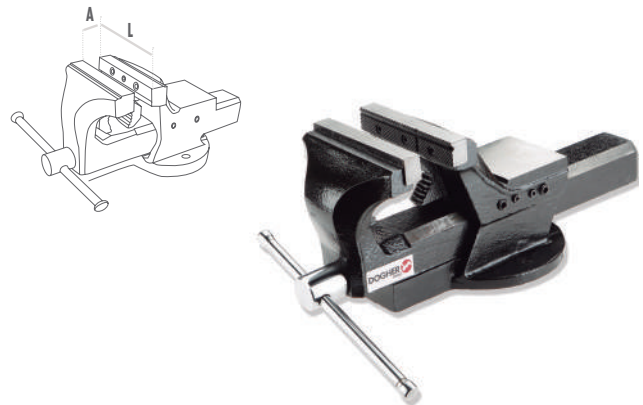

L mm	A mm	Kg	Ref	Price	Price
▶ 100	105	7,5	926-100	226,98 €	133,51 €
125	155	14	926-125	252,93 €	148,79 €
150	165	19	926-150	365,18 €	214,82 €
175	205	26	926-175	578,33 €	340,19 € ▶

• Base giratoria ver pag. 493 de Cat. general



MÁXIMAS PRESTACIONES

- 3 Módulos Desmontables
- 1 Caja de Herramientas
- 2 Cajones Alta Capacidad
- 1 Arcón Abatible

SOLUCIONES
3 EN 1

Ref 051-002

~~319,95 €~~ 188,21 €

490 x 300 x 720 mm

AMARRES INTERMÓDULO METÁLICOS

Más robusto, evita oscilaciones



CIERRES DE SEGURIDAD

Doble Cierre Metálico de Seguridad



ALOJAMIENTO CIERRE CON CANDADO



TROLLEY DE 3 MÓDULOS

+47 HERRAMIENTAS



300 mm
720 mm
490 mm

27 Pcs

1/2"



(531-080)

Vasos



8 • 9 • 10 • 11 • 12 • 13 • 14 • 15 • 16 • 17
18 • 19 • 20 • 21 • 22 • 23 • 24 • 27 • 30 • 32

72 dientes



Alargadores
250 mm
125 mm

Articulación Universal



Adaptador Triple Función

• 3/8" • 1/2" (524-021)

Vasos para Bujías



16 • 21

10 Pcs



(450-081)



6x7 • 8x9 • 10x11 • 12x13 • 14x15
16x17 • 18x19 • 20x22 • 21x23 • 24x26

10 Pcs



(330-084)

TESTED

Recta



4 • 5,5 • 6,5



PH1 • PH2

Plana



4 • 5,5 • 6,5



PH1 • PH2

Ref 051-500

~~874,77 €~~ 501,71 €

TROLLEY METÁLICA

COMPACTA

- Caja de herramientas con bandeja interior portátil
- 2 Cajones
- 1 Arcón abatible de gran capacidad
- Asa trasera telescópica desmontable



265 mm
550 mm
410 mm

CIERRES DE SEGURIDAD
Doble Cierre Metálico de Seguridad

Ref 051-008

~~192,49 €~~ 99,07 €

TROLLEY METÁLICA

COMPACTA

- 1 Caja de herramientas con bandeja interior portátil
- 4 Cajones (2 de alta capacidad)
- Asa trasera telescópica desmontable



265 mm
550 mm
410 mm

CIERRES DE SEGURIDAD
Doble Cierre Metálico de Seguridad

Ref 051-009

~~202,79 €~~ 119,28 €



TROLLEY
3 MÓDULOS



- 1 Arcón Abatible
- 1 Caja de Herramientas
- 3 Cajones Alta Capacidad
- Ruedas de plástico Alta Resistencia



Ref 051-004

~~181,85 €~~ **106,97 €** 505 x 330 x 835 mm

TROLLEY
2 MÓDULOS



- 1 Caja de Herramientas
- Organizador Circular
- 1 Arcón Alta Capacidad
- Bolsa de Nylon Frontal



Ref 051-005

~~113,29 €~~ **66,65 €** 485 x 310 x 635 mm

ORGANIZADOR
CON ASA RÍGIDA

- Cajas Organizadoras Extraíbles



Ref 052-006

~~16,44 €~~ **7,25 €**

210 x 338 x 62 mm

ORGANIZADOR
CON ASA MÓVIL ALTA CAPACIDAD

- Cajas Organizadoras Extraíbles



Ref 052-010

~~21,53 €~~ **9,50 €**

340 x 250 x 60 mm

CAJA DE HERRAMIENTAS
1 BANDEJA + 3 ORGANIZADORES

- Doble cierre metálico de seguridad
- Bandeja interior portátil

Ref 050-010

~~47,20 €~~ **27,07 €**



490 x 262 x 250 mm

CAJA DE HERRAMIENTAS
MÓVIL



- 3 Organizadores para Accesorios

Ref 051-006

~~148,80 €~~ **87,53 €**

620 x 370 x 420 mm



ARCÓN METÁLICO GALVANIZADO
CON CIERRE METÁLICO DE SEGURIDAD

L mm	Carga Máxima	Ref	159,90 €	94,06 €
555 x 230 x 210	40 kg	028-002	270,75 €	159,26 €
759 x 327 x 250	50 kg	028-003*	334,77 €	196,91 €
1.144 x 367 x 380	50 kg	028-004*	582,95 €	342,91 €
1.429 x 502 x 476	60 kg	028-005*		

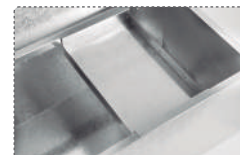

* Bandeja Incluida



CAJA METÁLICA DE HERRAMIENTAS +50 HERRAMIENTAS CALIDAD INDUSTRIAL

- Caja metálica Ref.: 026-001 incluida
- 5 Bandejas de Alta Calidad
- Carga Máxima de 30 Kg.



COMPOSICIÓN PROFESIONAL

Incluye Caja de Herramientas + 50 Herramientas



Ref 026-500
~~748,56 €~~ **432,12 €**



CAJA DE HERRAMIENTAS 5 BANDEJAS

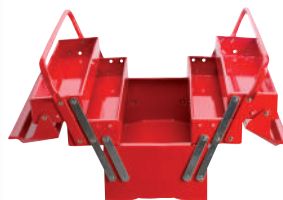

Ref 026-001
~~97,36 €~~ **57,25 €**
 495 x 200 x 230 mm

CAJA DE HERRAMIENTAS 3 BANDEJAS



Ref 026-002
~~76,90 €~~ **45,24 €**
 495 x 200 x 180 mm

CAJA DE HERRAMIENTAS 5 BANDEJAS SERIE LARGA



Ref 026-005
~~108,78 €~~ **63,99 €**
 550 x 200 x 208 mm

CAJA DE HERRAMIENTAS METÁLICA PROFESIONAL



Ref 026-003
~~131,75 €~~ **58,12 €**
 1 Bandeja
 2 Cajones
 • Doble Cierre Metálico de Seguridad
 • 30 kg Carga Máxima Total permitida
 510 x 218 x 250 mm

CAJA DE HERRAMIENTAS 1 BANDEJA + 6 CAJONES

- Bandeja superior
- 2 Asas laterales
- Cierre de seguridad con llave

• 5 kg Carga Máxima por Cajón

Ref 028-001
~~520,77 €~~ **306,34 €**
 668 x 316 x 386 mm





WATERPROOF TROLLEY

- Resistente al agua y totalmente hermético (IP 67)
- Apilable
- A prueba de corrosión, arena y polvo
- Resistente a los golpes. Irrompible y robusta
- Resistente a Temperaturas ente -40°C / +90°C
- Mango ergonómico, agarre recubierto de goma
- Cierres sin atasco con mecanismo de apertura fácil
- Bisagras metálicas a prueba de corrosión fabricadas con las mismas características de la cubierta
- Válvula de liberación de presión automático
- Anillo sellador
- Medida ext.: 568x467x274 mm / Medida int.: 546x392x233 mm
- Profundidad de la cubierta: 54 mm / Profundidad de la base: 179 mm



Ref 051-010



Ref 051-010

~~742,26 €~~ **436,62 €**

568 x 467 x 274 mm

TROLLEY INDUSTRIAL

Ref 051-510
~~2.564,60 €~~ **1.470,88 €**

• Ver Composición en pag. 41
Cat. general



139
Pcs



TROLLEY ELECTRICISTA

139
Pcs
Ref 051-511
~~2.812,85 €~~ **1.613,26 €**

• Ver Composición en pag. 42
Cat. general



TROLLEY ELECTRICISTA

Ref 051-512
~~2.558,80 €~~ **1.505,19 €**

• Ver Composición en pag. 43
Cat. general

67
Pcs

5331-001



ANTICORROSIÓN



RESISTENTE A ALTAS Y BAJAS TEMPERATURAS



A PRUEBA DE GOLPES

NOVEDAD

BAÚL EN POLIPROPILENO DE ALTA DENSIDAD CON RUEDAS



Ref 028-020
~~321,73 €~~ **188,31 €**

780 x 410 x 330 mm



- Baúl de gran resistencia
- Peso ligero y gran capacidad de carga
- Apto para uso exterior
- Asa frontal
- Ruedas de alta resistencia
- Opción de cierre mediante candado
- Apilable
- Ideal para construcción, mantenimiento y transporte



ANTICORROSIÓN



RESISTENTE A ALTAS Y BAJAS TEMPERATURAS



A PRUEBA DE GOLPES

D-BOX
by DOGHER TOOLS

MALETA COMPACTA PROFESIONAL DE GRAN CAPACIDAD

NOVEDAD



- Polipropileno moldeado por inyección
- Extremadamente ligera
- Asa ergonómica para fácil transporte
- Ruedas de gran resistencia
- Cerraduras laterales con llave
- Soportes metálicos de retención para los paneles portaherramientas
- Banda superior portadocumentos
- Incluye 2 organizadores en la base
- Zona inferior con divisores removibles

Ref 051-015

~~449,45 €~~ 263,06 €

430 x 320 x 190 mm



MALETA COMPACTA PROFESIONAL

+ 69 HERRAMIENTAS CALIDAD INDUSTRIAL

NOVEDAD

69 Pcs



Ref 051-515

~~1.019,03 €~~ 596,43 €



ANTICORROSIÓN



RESISTENTE A ALTAS Y BAJAS TEMPERATURAS



A PRUEBA DE GOLPES

TEKBOX
by DOGHER TOOLS

MALETA PROFESIONAL DE GRAN CAPACIDAD

NOVEDAD



- Polipropileno moldeado por inyección
- Asa ergonómica para fácil transporte
- Ruedas de gran resistencia
- Cerradura doble con dos llaves
- Etiqueta exterior identificativa
- Paneles portaherramientas removibles
- Compartimento inferior con divisores ajustables y removibles
- Bisagras metálicas de alta resistencia

Ref 051-016

~~567,79 €~~ 332,32 €

465 x 352 x 255 mm



MALETA PROFESIONAL

+94 HERRAMIENTAS CALIDAD INDUSTRIAL

NOVEDAD

94 Pcs



Ref 051-516

~~1.543,72 €~~ 903,53 €



Maleta de Aluminio



Ref 051-020

~~111,16 €~~ **65,37 €**

Maleta de Aluminio ligera y muy resistente con protecciones metálicas en las esquinas. Doble cierre con llave y asa bimetálica.

Gomas de apoyo en 2 caras para colocarla en cualquier superficie sin dañar la maleta.

El interior está compuesto por una bandeja móvil y otra fija en la cara superior aptas para colocar herramientas. La bandeja móvil, unida a la maleta por medio de 3 bisagras resistentes, se puede ajustar en 2 posiciones mediante una correa fijada a la tapa superior.



MALETA DE ALUMINIO LIGERA

+ 85 HERRAMIENTAS CALIDAD INDUSTRIAL

1/2"

- | | |
|--|--|
| | 8 • 10 • 12 • 13 • 14 • 15 • 16 • 17 • 18 • 19 • 21 • 22 • 24 • 27 • 30 • 32 |
| | 544-001 |
| | 543-003 |
| | 701-455 |
| | 396-001 |
| | 491-250 |
| | 605-009 |
| | 655-250 |
| | 052-014 |
| | 212-180 |
| | 208-160 |
| | 205-180 |
| | 296-006 |
| | 269-240 |
| | 789-001 |
| | 785-001 |
| | 778-05 |
| | 3x75 • 5,5x125 |
| | PH2x125 |
| | PZ2x125 |
| | 470-001 |
| | Plana |
| | 8 • 10 • 11 • 12 • 13 • 14 • 17 • 19 |
| | 438-001 |



85
Pcs



EXTERNAS 465 x 375 x 165 mm
INTERNAS 445 x 337 x 96 mm

Ref 051-520

~~839,28 €~~ **493,71 €**

**MOCHILA PORTAHERRAMIENTAS
CON RUEDAS**



- Máximas Prestaciones:
- Compartimentos Específicos para todo tipo de Herramientas
- Gran Capacidad de Almacenamiento
- Cremalleras de Apertura para Rápido Acceso Interior
- Asa Reforzada Ergonómica
- Mango telescópico
- Cintas Regulables de Rápida Adaptación

Ref 076-014

~~166,75 €~~ **98,09 €**

360 x 275 x 500/1050 mm

1 MOCHILA PROFESIONAL

+ 1 ORGANIZADOR + 32 HERRAMIENTAS



Ref 076-520

~~545,89 €~~ **321,10 €**

• Ver Composición en pag. 60
Cat. general

1 MOCHILA ELECTRICISTA

+ 1 ORGANIZADOR + 29 HERRAMIENTAS



Ref 076-521

~~520,78 €~~ **306,34 €**

• Ver Composición en pag. 60
Cat. general

MOCHILA PROFESIONAL PORTA HERRAMIENTAS

- Compartimentos Específicos para todo tipo de Herramientas
- Gran Capacidad de Almacenamiento
- Cremalleras de Apertura para Rápido Acceso Interior
- Contiene Bolsillo Específico para Organizador 052-014
- Asa Reforzada Ergonómica
- Cintas Regulables de Rápida Adaptación



- 410 x 295 x 240 mm
- 20 kg Carga máxima

Ref 076-004

~~79,70 €~~ **46,88 €**

*Herramienta no incluida

1 MOCHILA PROFESIONAL + 1 ORGANIZADOR + 32 HERRAMIENTAS



410 x 295 x 240 mm

Ref 076-500

~~458,84 €~~ **269,91 €**

· Ver Composición en pag. 59
Cat. general

Ref 076-501

~~433,73 €~~ **255,15 €**

· Ver Composición en pag. 59
Cat. general

CAJA PARA HERRAMIENTAS ABIERTA UNIVERSAL

- Barra rígida con refuerzo para su transporte
- Gran capacidad de almacenamiento
- Forro interior resistente al agua
- Alojamiento específicos para herramientas
- Asa y bandolera para un cómodo transporte



410 x 215 x 335 mm

Ref 076-002

~~76,71 €~~ **45,12 €**

*Herramienta no incluida

BOLSA PARA HERRAMIENTAS UNIVERSAL

- Apertura rígida para fácil acceso al interior
- Gran capacidad de almacenamiento
- Forro resistente al agua



520 x 250 x 290 mm

Ref 076-012

~~78,95 €~~ **46,44 €**

*Herramienta no incluida

FUNDA PORTA-HERRAMIENTAS CON ASA

- Asa reforzada ergonómica
- 18 compartimentos versátiles
- Cintas regulables de rápida adaptación



350 x 85 x 195 mm

Ref 076-003

~~49,81 €~~ **29,29 €**

*Herramienta no incluida

BOLSA PARA HERRAMIENTAS

- Gran capacidad de almacenamiento, imprescindible para el profesional.
- Bandolera para un cómodo transporte.
- Alojamiento específicos para herramientas tanto en el interior como en el exterior.



290 x 185 x 220 mm

Ref 076-006

~~55,56 €~~ **32,68 €**

*Herramienta no incluida

LÁMPARAS LED RECARGABLES



Modelo	Vega	Altair	Polux	Adhara	Compact	Stylo	Rigel	Shaula	Testa
Referencia	1000-001	1000-002	1000-003	1000-004	1000-009	1000-015	1000-020	1000-021	1000-030
Flujo Luminoso	700 lumens	400 lumens	450 lumens	UV 395nm	300 lumens	150 lumens	600 lumens	280 lumens	400 lumens
CRI	80	80	80	80	80	80	80	80/70	80
CCT	6500K	6500K	6500K	6500K	6500K	6500K	6500K	6000K/6500K	6500K
Nivel Protección	IP65/IK07	IP54/IK07	IP54/IK07	IP54/IK07	IP54/IK07	IP20/IK07	IP44/IK07	IP44/IK07	IP65/IK07
Niveles de Iluminación	3	1	2	2	2	1	2	5	2
Autonomía	4h	5h	5h	4h 30'	2h 30'	3h	3h 30'	1h 30'	4h
Batería 3.7 V	2600 mAh Li-ion	2600 mAh Li-ion	2600 mAh Li-ion	2600 mAh Li-ion	1500 mAh LiPo	800 mAh Li-ion	2600 mAh Li-ion	750 mAh Li-ion	1500 mAh Li-ion
Tiempo de Carga	3h 30'	3h 30'	3h 30'	3h 30'	2h 30'	1h 30'	3h 30'	2h	2h 30'
Luz Superior	150 lumens	120 lumens	100 lumens	100 lumens	NO	80 lumens	100 lumens	150 lumens	NO
	Base y Trasera	Base y Trasera	Base y Trasera	Base y Trasera	Base	Clip	Base	Base	NO
Articulación	180°	180°	180°	180°	Base Giratoria 360°	NO	180°	180°	4 Posiciones

LÁMPARA RECARGABLE 700 LUMENS COB LED

VEGA

Ref 1000-001

~~91,50 €~~ **53,56 €**

268 x 61 x 42 mm

LÁMPARA RECARGABLE 400 LUMENS COB LED

ALTAIR

Ref 1000-002

~~90,35 €~~ **52,88 €**

268 x 61 x 42 mm

LÁMPARA RECARGABLE 450 LUMENS COB LED

POLUX

Ref 1000-003

~~89,10 €~~ **52,15 €**

199 x 51 x 36 mm

LÁMPARA UV RECARGABLE 395nm WAVELENGTH COB LED

ADHARA

Ref 1000-004

~~92,25 €~~ **54,00 €**

199 x 51 x 36 mm

LÁMPARA RECARGABLE 300 LUMENS COB LED

COMPACT

Ref 1000-009

~~96,21 €~~ **56,31 €**

127 x 69 x 33 mm

LÁMPARA RECARGABLE 150 LUMENS COB LED

STYLO

Ref 1000-015

~~78,36 €~~ **45,87 €**

167 x 25 x 33 mm

LÁMPARA RECARGABLE
600 LUMENS COB LED

RIGEL



Ref 1000-020

~~96,36 €~~ **56,40 €**

397 x 66,5 x 46 mm

LÁMPARA RECARGABLE
280 LUMENS COB LED

SHAULA



Ref 1000-021

~~73,10 €~~ **42,78 €**

307 x 30 x 17 mm

LÁMPARA FRONTAL
400 LUMENS COB LED

TESTA



Ref 1000-030

~~56,36 €~~ **32,99 €**

47,5 x 78,5 x 42 mm

• Banda Ergonómica de Alta Calidad, ajustable y antideslizante.

• 4 Ángulos de posicionamiento

• Sensor de Movimiento ON/OFF sin contacto.

BOMBA DE ENGRASE

BOMBA DE ENGRASE CON MANGUERA FLEXIBLE

8.000 PSI

1/8 BSP



915-030



• Válvula de liberación de Aire
• Carga Granel

Granel cc	Cartucho gr	L bomba	Ø bomba	L manguera	Ø manguera	Ref	
500	400	350	57,5	300	8,5	915-030	
							38,18 € 22,46 €

PISTOLA DE SOPLADO PROGRESIVA

Ø mm 8

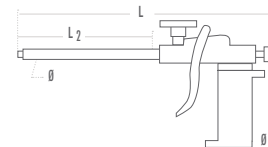

L mm	L2 mm	Ø mm	Ø2 mm	Ref	
210	100	8	1/4" G (BSP)	914-010	
					19,32 € 11,37 €

• Presión máxima: 12 Bar · 175 PSI · 1,2 Mpa
• Boquilla con refuerzo metálico.
• Cuerpo de POM (Acetal) de alto rendimiento.



L mm	L2 mm	Ø mm	Ø2 mm	Ref	
306	202	8	1/4" G (BSP)	914-015	
					22,66 € 13,32 €

• Presión máxima: 12 Bar · 175 PSI · 1,2 Mpa
• Boquilla con refuerzo metálico.
• Cuerpo de POM (Acetal) de alto rendimiento.

ALICATES

MULTI SEEGER



Alicate posición Arandela interior



Alicate posición Arandela exterior



Bocas curvas intercambiables



Bocas rectas intercambiables



Almacén para bocas

6 EN 1



▶ 200 mm Ref 220-001
~~47,73 €~~ **28,07 €**

- Función Seeger interior / exterior con bocas rectas y curvas
- Incluye 3 pares de puntas de recambio:
 1 par puntas rectas + 2 pares puntas curvas

ALICATES

SEEGER PRO

- Puntas reforzadas
- Mayor durabilidad y resistencia

ALICATE SEEGER PRO RECTO EXTERIOR



L mm	∅ Min mm.	∅ Max mm.	Ref	Price	Price
▶ 140	3	10	220X-140	27,90 €	16,21 €
140	10	25	220X-155	24,92 €	14,49 €
180	19	60	220X-180	29,10 €	16,90 €
240	40	100	220X-220	33,64 €	19,54 €
330	85	140	220X-300	55,57 €	32,28 € ▶

ALICATE SEEGER PRO CURVO EXTERIOR



L mm	∅ Min mm.	∅ Max mm.	Ref	Price	Price
▶ 130	3	10	221X-140	27,90 €	16,21 €
130	10	25	221X-155	25,40 €	14,75 €
170	19	60	221X-180	28,69 €	16,66 €
220	40	100	221X-220	34,26 €	19,91 €
315	85	140	221X-300	55,57 €	32,28 € ▶

ALICATE SEEGER PRO RECTO INTERIOR



L mm	∅ Min mm.	∅ Max mm.	Ref	Price	Price
▶ 140	8	13	222X-140	27,90 €	16,21 €
140	12	25	222X-155	25,40 €	14,75 €
180	19	60	222X-180	29,10 €	16,90 €
230	40	100	222X-220	33,64 €	19,54 €
320	85	140	222X-300	55,57 €	32,28 € ▶

ALICATE SEEGER PRO CURVO INTERIOR



L mm	∅ Min mm.	∅ Max mm.	Ref	Price	Price
▶ 125	8	13	223X-140	27,90 €	16,21 €
125	12	25	223X-155	25,40 €	14,75 €
170	19	60	223X-180	29,10 €	16,90 €
220	40	100	223X-220	34,57 €	20,07 €
300	85	140	223X-300	55,57 €	32,28 € ▶

ESTUCHE CREMALLERA SEEGER PRO



L mm	∅ Min mm.	∅ Max mm.	Ref	Price	Price
▶ 155	12	25	220X-004	110,37 €	64,10 €
180	19	60	220X-002	125,24 €	72,74 € ▶



290 x 215 mm

**LLAVE STILLSON
ALUMINIO PROFESIONAL**

- Dureza en Bocas 60 HRc
- Apertura 38% mayor que Stillson Forjada
- Cuerpo de Aluminio, 40% más ligero
- Cuerpo Monoblock, mayor Robustez



CrV



L"	L mm	Ø max.	Ref	Price	Price
▶ 10	250	Ø49	655-250	49,89 €	28,62 €
14	350	Ø60	655-350	66,48 €	38,13 €
18	450	Ø76	655-450	95,05 €	54,51 €
24	600	Ø90	655-600	140,89 €	80,81 €
36	900	Ø140	655-900	280,81 €	161,04 €
48	1210	Ø168	655-1210	453,85 €	260,29 € ▶

**LLAVE STILLSON
FORJADA PROFESIONAL**

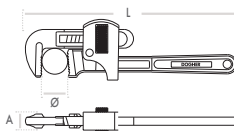

60HRc

CrV



L"	L mm	Ø max.	Ref	Price	Price
▶ 8	200	Ø25	650-200	27,21 €	15,60 €
10	250	Ø35	650-250	36,08 €	20,69 €
12	300	Ø44	650-300	41,52 €	23,81 €
14	350	Ø50	650-350	45,88 €	26,31 €
18	450	Ø60	650-450	62,02 €	35,56 €
24	600	Ø76	650-600	100,92 €	57,87 €
36	900	Ø102	650-900	207,54 €	119,03 € ▶

**LLAVE DE CADENA
PROFESIONAL**

CrV



L"	L mm	Ø mm	Ref	Price	Price
▶ 12	300	90	662-001	53,42 €	31,43 € ▶

**DOBLADORA MULTIUSO
DE TUBO**



NOVEDAD

▶ Ref 662-020
~~42,36 €~~ 24,79 €

· Para Tubo de 6-8-10 mm



**CORTATUBOS
PARA PVC RETROCESO AUTOMÁTICO**

PPRC

Soft TOUCH



Position 1 **Ø27 mm**
Position 2 **Ø45 mm**



▶ 0-45 mm Ref 665-45
~~73,48 €~~ 43,22 €

- Corta polietileno, Ppr, Multicapa, PEX...
- Pasador para Selección Capacidad de Corte (27 a 45 mm)
- Cuchilla de Acero Forjado y Templado

**CORTATUBOS
REGULABLE PARA METAL**

Cu
Al
Inox



▶ 3-32 mm Ref 675-03-32
~~26,33 €~~ 15,10 €

Incluye Rebarbador

LLAVES CABINA DE AGUA, GAS Y ELECTRICIDAD

Ref 470-001

~~23,37 €~~ **13,74 €**

LLAVES CABINA CALEFACCIÓN Y AIRE ACONDICIONADO

Ref 470-002

~~23,79 €~~ **13,99 €**

TENACILLA DE AJUSTE RÁPIDO CON BOTÓN

- Boca más alargada y estrecha
- Mayor accesibilidad en espacios reducidos
- Cuerpo forjado en Acero Cromo-Vanadio
- Mango antideslizante de PVC
- Acabado pavonado anticorrosivo
- Bocas templadas en aceite. Mayor resistencia y durabilidad
- Botón con 4 dientes de bloqueo
- 35% más de apertura

C+V



L mm	Ø max. mm	Ref		
▶ 150	26	269-150	40,46 €	23,68 €
180	38	269-180	43,25 €	24,81 €
240	50	269-240	46,14 €	26,46 €
300	70	269-300	57,29 €	32,87 €
400	90	269-400	100,93 €	57,88 € ▶

TENACILLA AJUSTABLE DE BOTÓN STD

C+V

L mm	Ø max. mm	Ref			
▶ 150	26	2690-150	26,36 €	15,43 €	NOVEDAD
180	38	2690-180	30,25 €	17,71 €	NOVEDAD
250	50	2690-250	33,14 €	19,01 €	
300	70	2690-300	46,75 €	26,81 €	▶

TENACILLA DE APERTURA MÚLTIPLE DE CANAL

C+V

L mm	Ø mm	Ref		
▶ 250	37	268-250	23,82 €	14,01 € ▶

TENACILLA DE APERTURA MÚLTIPLE DE CANAL MANGO ANTIDESLIZANTE

C+V

L mm	Ø mm	Ref		
▶ 250	48	267-250	31,97 €	18,79 € ▶



TENSADOR DE BRIDAS

C+V

L mm	Max mm	Ref		
▶ 190	12 x 2,3	268-010	58,63 €	34,31 €

NOVEDAD



FUNDA NYLON ALICATES TOP Plier

Ref 210-002

~~72,81 €~~ **42,82 €**



TENAZAS GRIP AUTOAJUSTABLE



- Ajuste de presión mediante mecanismo interno.
- Mangos moleteados antideslizantes.
- Bocas templadas para mayor durabilidad.
- Tenaza grip AUTOMATIC patentada.

AUTOMATIC



CrMo

L mm	L "	Ref
150	6	275-005
250	10	275-010

AUTOMATIC

46,20 €	27,04 €	NOVEDAD
50,38 €	29,63 €	

TENAZA GRIP DE BOCA RECTA SIN CORTE AUTOAJUSTABLE



CrMo

L mm	L "	Ø mm	Ref
250	10	48	277-010

AUTOMATIC

54,45 €	31,87 €
--------------------	----------------

NOVEDAD

TENAZAS GRIP BOCA CURVA SIN CORTE



- Bocas Curvas: Bocas de gran apertura indicadas para formas redondas. Utilizado en talleres, fontanería, calefactores etc. Bocas curvas y finas de gran capacidad: Permiten un agarre firme sobre formas redondeadas

100% Más de agarre

L mm	L "	Ref	Price	Price
175	7	275-175	27,50 €	16,18 €
250	10	275-250	31,24 €	18,37 €



TENAZAS GRIP BOCA CURVA CON CORTE



L mm	L "	Ref	Price	Price
175	7	276-175	26,63 €	15,66 €
250	10	276-250	29,03 €	17,07 €

TENAZAS GRIP BOCA CURVA



L mm	Ø mm	P mm	Ref	Price	Price
250	85	73	275F-011	72,51 €	42,66 €

TENAZA GRIP



CrV

L mm	L "	B mm	A mm	Ref
200	8	70	30	275-050

AUTOMATIC

75,14 €	43,99 €
--------------------	----------------

NOVEDAD

TIJERA DE INGLETE

49,08 €	28,87 €
--------------------	----------------

Ref 285-45-135

SK5

45°
135°

- Acero endurecido con mango antideslizante.
- Para gomas, perfiles y canaletas de ancho 40 mm máx. y largo de 25 mm máx.
- Para cortes rectos y ángulos de 45° - 135°



TIJERAS

CUT-PRO

- Microdentado anti deslizante.
- Mango bimaterial.

Inox

CUT
PRO

TIJERAS

MULTIFUNCIÓN

NOVEDAD

< 0.8 mm < 1.2 mm < 0.5 mm < 0.4 mm < 4.0 mm < 5.0 mm < Ø10 mm

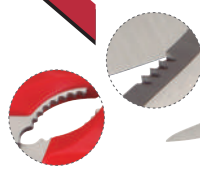

Inox

▶ 206 mm Ref 296-011
~~25,23 €~~ 14,76 €

TIJERA CUT-PRO
PARA ELECTRICISTA

- Alojamiento especial para cable. 1,5mm²/2,5mm²/4 mm²
- Capacidad máx. de corte hasta 1x80 mm²
- Cuerpo íntegro de acero inoxidable
- Prensa terminales 2,5mm²

▶ 170 mm Ref 296-010
~~47,67 €~~ 28,04 €

TIJERA CUT-PRO XXL
PARA ELECTRICISTA

Inox



- Capacidad máx. de corte hasta 1x50 mm²
- Cuerpo íntegro acero inox
- Prensa Terminales y pelacables 1,5mm²/2,5mm².

▶ 160 mm Ref 296-009
~~35,78 €~~ 21,04 €

TIJERA CUT-PRO
PARA ELECTRICISTA

Inox



▶ 150 mm Ref 296-008
~~23,16 €~~ 13,62 €

TIJERA
PARA ELECTRICISTA EMPUÑADURA XXL

Inox



- Hoja de sierra
- Empuñadura bimaterial
- Corte máximo 1 x 50 mm²

▶ 150 mm Ref 296-004
~~27,38 €~~ 15,90 €

TIJERA
PARA ELECTRICISTA

- Hoja de sierra
- Empuñadura bimaterial

Inox



▶ Ref Tijera+Funda 296-007
~~26,81 €~~ 15,40 €

▶ 145 mm Ref 296-006
~~22,69 €~~ 13,34 €

PELAMANGUERAS
PELACABLES

· Ø 4 - 28 mm 5/32" - 1 1/8" · Ø 0,5 - 6 mm² 20 - 10 AWG

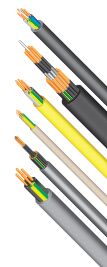

▶ Ref 296-132
~~38,22 €~~ 22,47 €

PELACABLES
AUTOMÁTICO AJUSTABLE

· Ø 0,2-6 mm² 24-10 AWG



▶ Ref 296-152
~~48,45 €~~ 28,50 €

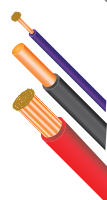

JUEGO CRIMPADORA



- Acero tratado de gran resistencia al desgaste.
- Mecanismo de cambio rápido de bocas.
- Sistema de bloqueo/desbloqueo.
- Mango ergonómico bi material.



Ref 296-064

~~182,37 €~~ 106,74 €

CRIMPADORA DE CARRACA PARA TERMINALES DE CONEXIÓN SOLAR



225
mm

9"

MC4



- Cabeza templada de acero forjado de gran resistencia.
- Mango bi-material.
- 2,5 - 4 - 6 mm²
- AWG 14 - 12 - 10

PATENTED

Ref 296-066

~~130,37 €~~ 76,31 €

CRIMPADORA CARRACA PARA PUNTERAS HUECAS AISLADAS Y ACCESO LATERAL



0,25-16 mm²

Ref 296-061

~~96,67 €~~ 56,87 €

- Alta calidad de prensado gracias al cierre uniforme de las garras en forma de cuadrado (Mecanismo de autoapertura).
- Perfil de crimpadora robusto con tratamiento antidesgaste
- Para punteras: 0,25 ~ 16mm².
- Muelle fabricado con acero de la mejor calidad para uso intensivo.
- Mango bimatereial ergonómico para uso intensivo.
- Acceso lateral de la puntera.
- Cuerpo fosfatado para evitar corrosión.



PRENSA TERMINALES AISLADOS DE CARRACA



- Rango de terminales aislados 1.5-2,5-6mm²
- Bocas templadas y endurecidas
- Mecanismo controlado de carraca
- Multiplicador de fuerza
- Sistema de bloqueo
- Mango ergonómico

220 mm Ref 296-060

~~37,85 €~~ 22,26 €

TELE CRIMPADORA DE CARRACA



203 mm



Ref 296-062

~~84,60 €~~ 49,76 €

- Para crimpado de terminales western tipo RJ45 y RJ11 de 6 y 8 polos.
- Cuchilla para cables de 6 a 12 mm.
- Muelle fabricado con acero de la mejor calidad para uso intensivo.
- Mango bimatereial ergonómico para uso intensivo.
- Cuerpo fosfatado para evitar corrosión.

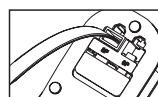

- Apriete el mango para activar la acción de prensado.

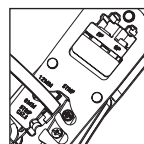

- Pelar el cable plano.

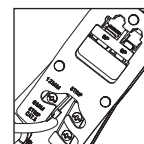

- Pelar el cable redondo CAT.5.

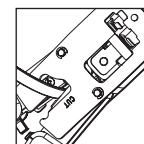

- Cortar cables de red.

ALICATE PARA PUNTERAS HUECAS

225
mm

9"



Ref 296-063

~~78,26 €~~ 45,81 €

- Para el crimpado de punteras huecas. Terminales aislados y no aislados.
- Eje desplazado para multiplicar el par y disminuir esfuerzos.
- Mordazas en forma semicircular.
- Mango bi-material.
- 0.5 - 0.75 - 1 - 1.5 - 2.5 - 4 - 6 - 10 - 16 mm²

NOVEDAD

ALICATE PARA PUNTERAS HUECAS

150
mm

6"



Ref 296-065

~~58,61 €~~ 34,31 €

- Para el crimpado de punteras huecas.
- Terminales aislados y no aislados.
- Eje desplazado para multiplicar el par y disminuir esfuerzos.
- Mango bi-material con muelle incorporado.
- 0.25 - 0.50 - 0.75 - 1 - 1.5 - 2.5 mm²

NOVEDAD

ALICATE PARA TERMINALES

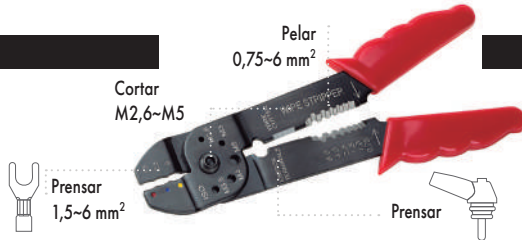

▶ 250 mm Ref 296-056
~~16,06 €~~ 9,44 €

CORTACABLES DE CARRACA

52
mm280
mm

- Cortacables de carraca forjado en acero especial para herramientas.
- Corte de cable de cobre y aluminio simples y múltiples.
- Especial para trabajos en lugares de difícil acceso.
- Filos de corte templados.
- Bloqueo de seguridad.
- Palanca de liberación de presión.
- Mango bimaternal con zona de apoyo.

Cu 300 mm²
Al 400 mm²



L mm Ref
 ▶ 280 295-021 ~~387,11 €~~ 227,72 € ▶

PELAMANGUERAS PROFESIONAL



- Cuchilla SK2 rectificada
- Mango antideslizante
- Ruleta para el ajuste de la profundidad de corte

L mm mm Ref
 ▶ 190 8~28 296-031 ~~24,39 €~~ 14,35 € ▶



NAVAJA PARA ELECTRICISTA

195
mm

Inox



L mm Ref
 ▶ 195 296-021 ~~19,54 €~~ 11,50 € ▶

CORTACABLES PROFESIONAL



Cr-V



- Corte de cable de cobre y aluminio simples y múltiples sin armar.
- Filos de corte templados.
- Mango tubular de acero.

A max.



L mm mm² A Max. Ref
 ▶ 530 250 23,6 295-014 ~~231,94 €~~ 135,75 € ▶

DESTORNILLADORES AISLADOS VDE 1000V

- Mango Bimaterial Aislado
- Varilla Circular Aislada
- Certificado VDE de Garantía
- 56 HRc



7 DESTORNILLADORES AISLADOS 1000V

- Recta 3 · 4 · 5,5 · 6,5
- PH0 · PH1 · PH2



Ref 360-001
~~74,22 €~~ **43,66 €**

6 DESTORNILLADORES AISLADOS 1000V

- Recta 3 · 4 · 5,5 · 6,5
- PH1 · PH2

Ref 360-005

~~66,70 €~~ **38,26 €**



ESTUCHE CREMALLERA 5 HERRAMIENTAS AISLADAS

- Recta 4 · 5,5
- PH1 · PH2

Alicate Aislado Corte Diagonal
 Ref. 255-160



Ref 360-008
~~88,69 €~~ **51,91 €**

ALICATES AISLADOS FUNDA DE NYLON



160 mm



180 mm

160 mm



Ref 250-002
~~123,71 €~~ **70,96 €**

JUEGO DE DESTORNILLADOR VARILLAS INTERCAMBIABLES 14 PIEZAS

- 1 Mango
- 1 Tapón
- 1 Destornillador tipo tester
- 11 Varillas intercambiables :

2,5 · 3,5 · 4,0 · 5,5 · 6,5

PH0 · PH1 · PH2

T10 · T15 · T20



Ref 360-012
~~77,83 €~~ **45,78 €**

MALETÍN DE HERRAMIENTAS VDE 19 PIEZAS



390 mm
 675 mm
 705 mm

Ref 080-001
~~267,67 €~~ **157,46 €**



Alicate Aislado Bocas Semirredondas con Corte 251-200



Alicate Pelacables Aislado 257-160



4 Destornilladores de Precisión + Tapón



Tester 396-001

2 Rollos de Cinta Aislante



Destornillador Boca Recta 360-025-075
 360-040-100
 360-055-125
 360-065-150
 360-080-175



Destornillador Boca Phillips 361-PH0-060
 361-PH1-080
 361-PH2-100

Alicate Aislado Corte Diagonal 255-160

Alicate Aislado Universal 250-180



255-160



250-180

JUEGO DE VASOS VDE 1/2" 20 PIEZAS



80 mm
 320 mm
 415 mm



10 · 11 · 12 · 13 · 14 · 16 · 17 · 18 · 19 · 21 · 22 · 24 · 27

Vasos con Puntas
 Llave de Carraca L 250 mm
 Alargador 250 mm
 Llave en "T" L 200 mm

4 · 5 · 6 · 8 · L 120 mm



Ref 5331-001
~~577,13 €~~ **339,49 €**

DESTORNILLADORES SERIE INDUSTRIAL PLUS

- Poliuretano antideslizante
- Poliamida alta resistencia
- Doble refuerzo
- Varilla hexagonal y hexágono conductor 58 HRc

S2



MAYOR FIRMEZA

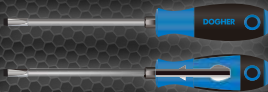

6 DESTORNILLADORES SERIE INDUSTRIAL PLUS

Recta
3 · 4 · 5 · 6

PH1 · PH2

Ref 300-001

~~62,51 €~~ **35,85 €**



DESTORNILLADORES SERIE PROFESIONAL

5 DESTORNILLADORES PROFESIONALES

CrMo



Recta
5,5 · 6,5

Ref 330-001

PH1 · PH2 · PH3 ~~43,38 €~~ **25,51 €**

7 DESTORNILLADORES PROFESIONALES

CrMo



Plana
3 · 4 · 5,5 · 6,5

Ref 330-003

PH0 · PH1 · PH2 ~~49,02 €~~ **28,84 €**

7 DESTORNILLADORES PROFESIONALES

CrMo



Plana
3 · 4 · 5,5 · 6,5

Ref 330-004

PZ0 · PZ1 · PZ2 ~~50,53 €~~ **29,72 €**

6 DESTORNILLADORES PROFESIONALES

CrMo

NOVEDAD



Recta
2,5 · 3 · 3,5 · 4 · 5,5 · 6,5

Ref 331-001

~~41,23 €~~ **24,13 €**

6 DESTORNILLADORES PROFESIONALES

CrMo

NOVEDAD



Plana
2,5 · 3 · 4 · 5,5 · 6,5 · 8

Ref 330-009

~~47,19 €~~ **27,62 €**

6 DESTORNILLADORES PASANTES PROFESIONALES

CrMo

NOVEDAD



Plana
5,5 · 6,5 · 8

PH1 · PH2 · PH3

Ref 375-005

~~75,28 €~~ **44,06 €**

DESTORNILLADORES DE PRECISIÓN

Varilla Circular
Mango Bimaterial
56 HRc

CrMo



1,5 · 2 · 2,5 · 3

PH00 · PH0 · PH1

Ref 380-002

~~40,38 €~~ **23,75 €**

7 DESTORNILLADORES DE PRECISIÓN



EXTRACTORES DE RETENES

6
Pcs



- Extractor Retén Forma de Garra
- Extractor Retén Forma Recta
- Extractor Retén Punta 90°
- Extractor Retén en Ángulo de 90°
- Extractor O-Ring

Ref 330-101

~~68,63 €~~ **40,16 €**

PUNTAS DE IMPACTO

- Acero de alta tecnología S2
- Máxima resistencia a la torsión
- Alta tenacidad
- Geometría específica, ofrece máxima durabilidad.

30 mm

1/4"

S2



Bluefire

PUNTAS DE IMPACTO PUNTA PHILLIPS

1/4"



Ref

PH2

2

427-PH2-2

~~11,87 €~~

6,99 €



PUNTAS DE IMPACTO PUNTA POZIDRIV

1/4"



Ref

PZ2

2

427-PZ2-2

~~11,87 €~~

6,99 €



PUNTAS DE IMPACTO PUNTA TORX

1/4"



Ref

T10

2

427-T10-2

~~12,08 €~~

7,10 €

T15

2

427-T15-2

~~12,08 €~~

7,10 €

T20

2

427-T20-2

~~12,08 €~~

7,10 €

T25

2

427-T25-2

~~12,08 €~~

7,10 €

T30

2

427-T30-2

~~12,08 €~~

7,10 €

T40

2

427-T40-2

~~12,08 €~~

7,10 €

• No se suministra en unidades de embalaje distintas a las indicadas.

KIT DE VASOS PORTAPUNTAS

KIT DE VASOS MAGNÉTICOS

3 Vasos Magnéticos 50 mm 8 · 10 · 13

1/4"



Ref 440-001

~~20,81 €~~

12,24 €

PORTAPUNTAS DE IMPACTO MAGNÉTICO CON ANILLO

60 mm

1/4"

1/4"



Ø 15



L mm



Ref

60

1

443-002

~~19,22 €~~

11,31 €

KIT DE VASOS MAGNÉTICOS Y PORTAPUNTAS

5 Vasos Magnéticos 50 mm 6 · 7 · 8 · 10 · 13
2 Portapuntas 1/4: 50-74 mm

1/4"



6 · 7 · 8 · 10 · 13

Ref 440-007

~~56,74 €~~

33,37 €



PORTAPUNTAS MAGNÉTICO SDS PLUS CON ANILLO

78 mm

1/4"



SDS Plus



L mm



Ref

78

1

445-001

~~15,76 €~~

9,26 €

PORTAPUNTAS MAGNÉTICO CON ANILLO

1/4"

1/4"



L mm



Ref

50

1

443-050

~~6,42 €~~

3,76 €

74

1

443-074

~~11,43 €~~

6,72 €



ADAPTADOR FLEXIBLE

1/4" 1/4" 300 mm



Ref 444-001

~~32,53 €~~ 19,13 €

ATORNILLADOR ANGULAR PARA PUNTAS DE 1/4"

- Válido para puntas de atornillar y brocas con mango hexagonal
- Diseñado para trabajar en espacios reducidos
- Se recomienda usar exclusivamente en taladros atornilladores de batería

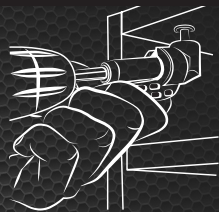

Ref 443-001

~~32,31 €~~ 19,00 €

ATORNILLADOR ARTICULADO DE CARRACA

- Reversible
- Mango ergonómico bimaterial
- Bola de Retención de Seguridad
- Pulsador de Desbloqueo

1/4" CrV



POSICIONAMIENTO DE 0°- 45°- 90°



180mm Ref 343-007
~~19,89 €~~ 11,69 €

58 PUNTAS 1/4" DESTORNILLADOR DE CARRACA

- 3 · 4 · 4,5 · 5 · 6 · 7 · 8
- PH0 · PH1 · PH2 · PH3
- PZ0 · PZ1 · PZ2 · PZ3
- T5 · T6
- TS7 · TS8 · TS9 · TS10 · TS15 · TS20 · TS25 · TS30 · TS40
- HX1,5
- HXS2,0 · HXS2,5 · HXS3,0 · HXS4,0 · HXS5,0 · HXS6,0
- 1 · 2 · 3
- XZN4 · XZN5 · XZN6 · XZN8
- R0 · R1 · R2 · R3
- TW1 · TW2 · TW3 · TW4
- TQ06 · TQ08 · TQ10
- 4 · 6 · 8 · 10

S2



Adaptador 1/4" ◀ ▶ 1/4" (509-030)
Portapuntas Magnético con Anillo · 60 mm
Atornillador Ref. 343-007

Ref 438-008
~~71,19 €~~ 41,88 €

ESPEJO TELESCOPICO PARA TALLER



L min-max. 240-930 Ø 56,5 mm

Ref 930-001
~~16,17 €~~ 9,51 €

IMÁN TELESCÓPICO CON CLIP

680 g







L mm → ← mm Ref
▶ 635 7 343-020

~~10,91 €~~ 6,41 € ▶

32 PIEZAS

PUNTAS Y PORTAPUNTAS

-  T06 · T07 · T08 · T09 · T10 · T15
T20 · T25 · T27 · T30 · T40
-  HX3 · HX4 · HX5 · HX6
-  3 · 4 · 5 · 6 · 7
-  PH0 · PH1 · PH2 (x3) · PH3
-  PZ0 · PZ1 · PZ2 · PZ3

Adaptador 1/4"  1/4" (509-030)
Portapuntas Magnético con Anillo · 60 mm



1/4" **25 mm**

Ref 438-001











~~41,94 €~~ **24,66 €**

JUEGO DE DESTORNILLADOR CON VARILLAS INTERCAMBIABLES

- 1 Mango portavarillas Profesional
- 10 Varillas intercambiables con 2 puntas de atornillar diferentes

20 destornilladores en 1 · Varillas de doble punta

!!! La solución al atornillado en tu bolsillo !!!

-  3 · 4
-  PH0 · PH1
-  PZ0 · PZ1
-  T10 · T15
-  HX2 · HX3
-  5,5 · 6,35
-  PH2 · PZ2
-  PZ/FL1 · PZ/FL2
-  T20 · T25
-  HX4 · HX5











Ref 330-050

~~70,99 €~~ **41,75 €**

51 PIEZAS

DESTORNILLADOR DE PRECISIÓN CON PUNTAS

-  1 · 1,5 · 2 · 2,5 · 3 · 3,5 · 4
-  PH000 · PH00 · PH0 · PH1
-  PZ000 · PZ00
PZ0 · PZ1 · PZ2
-  T3 · T4 · T5 · T6 · T7
T8 · T9 · T10 · T15 · T20
-  TS7 · TS8 · TS9 · TS10
TS15 · TS20
-  HX0,7 · HX0,9 · HX1,3
HX1,5 · HX2,0 · HX2,5
HX3,0 · HX3,5 · HX4,0
-  HS2,0 · HS2,5
HS3,0 · HS4,0
-  HR1,5 · HR2,0 · HR2,5
HR3,0 · HR4,0

Ref 380-005

~~75,67 €~~ **44,50 €**



DEDO MAGNÉTICO FLEXIBLE

NOVEDAD

680 mm **27"**
1kg

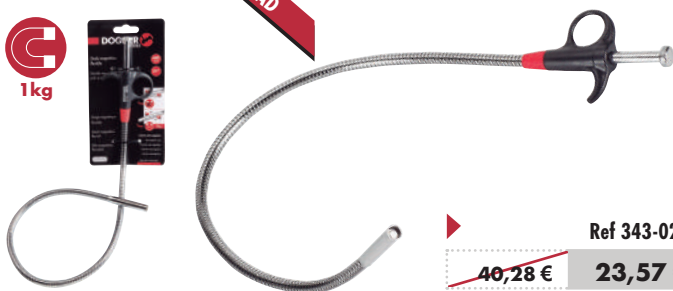

Ref 343-021

~~40,28 €~~ **23,57 €**

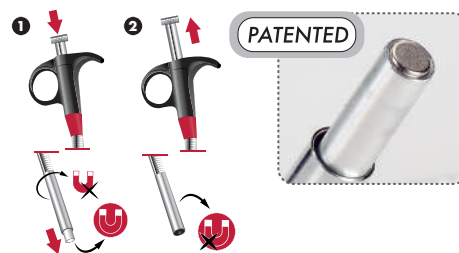

• Cubierta Anti-magnética.

PINZA FLEXIBLE DE 3 GARRAS

NOVEDAD

700 mm **27,5"**
1,2kg

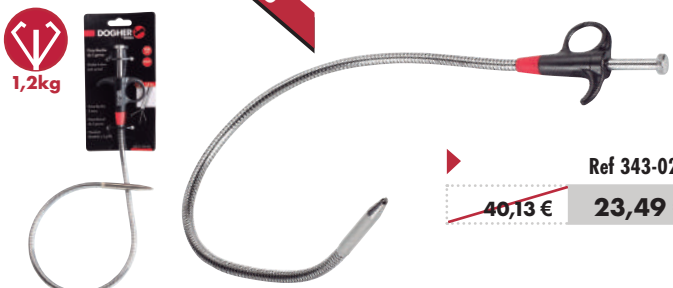

Ref 343-026

~~40,13 €~~ **23,49 €**

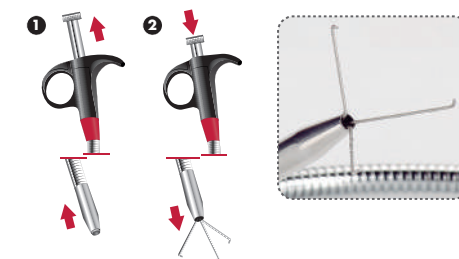

LLAVES

AJUSTABLES



- Ajuste en bocas de máxima precisión
- Apriete más rígido
- Tornillo de arrastre preciso, sin holguras
- Ángulo de 15°, aumenta el par con menor esfuerzo

15°



LLAVES AJUSTABLES

MOLETA LATERAL



L mm	L"	mm	Ref		
▶ 150	6	24	491-150	33,27 €	19,57 €
200	8	29	491-200	37,13 €	21,84 €
250	10	33	491-250	45,85 €	26,97 €
300	12	38	491-300	58,04 €	34,15 €
400	16	50	491-400	96,53 €	56,78 €
500	20	62	491-500	175,24 €	103,09 € ▶

LLAVES AJUSTABLES

MOLETA CENTRAL PRO



L mm	L"	mm	Ref		
▶ 100	4	17	493-100	23,33 €	13,38 €
150	6	24	493-150	24,02 €	13,76 €
200	8	29	493-200	27,57 €	15,81 €
250	10	33	493-250	33,71 €	19,34 €
300	12	38	493-300	44,19 €	25,35 €
380	15	50	493-380	75,18 €	43,12 €
450	18	60	493-450	118,05 €	67,71 €
600	24	70	493-600	293,29 €	168,21 € ▶

LLAVES AJUSTABLES

GRAN APERTURA



L mm	L"	mm	Ref		
▶ 150	6	34	492-150	34,47 €	19,76 €
200	8	38	492-200	37,39 €	21,44 €
250	10	50	492-250	45,80 €	26,26 € ▶

LLAVES AJUSTABLES

MOLETA CENTRAL STD



L mm	L"	mm	Ref		
▶ 100	4	13	4930-100	16,37 €	9,40 €
150	6	19	4930-150	16,53 €	9,49 €
200	8	24	4930-200	19,09 €	10,94 €
250	10	28	4930-250	23,97 €	13,74 €
300	12	34	4930-300	30,95 €	17,75 €
380	15	43	4930-380	55,60 €	31,88 €
450	18	52	4930-450	85,48 €	49,03 €
600	24	62	4930-600	180,85 €	103,72 € ▶

LLAVES

AJUSTABLES



200 mm • 8" **Alligator**

32 mm M3-M10 CrV



Alligator

▶ Ref 4931-200
~~40,98 €~~ **24,10 €**

LLAVES FIJAS DE DOBLE BOCA ABIERTA



8 LLAVES

FIJAS

6x7 · 8x9 · 10x11 · 12x13 · 14x15 · 16x17 · 18x19 · 20x22



390 x 300 mm

Ref 450-001

~~77,05 €~~ 45,32 €



Ref 450-018

~~79,05 €~~ 46,50 €

10 LLAVES

FIJAS

6x7 · 8x9 · 10x11 · 12x13 · 14x15
16x17 · 18x19 · 20x22 · 21x23 · 24x27



Ref 450-020

~~111,48 €~~ 65,57 €

12 LLAVES

FIJAS

6x7 · 8x9 · 10x11 · 12x13 · 14x15 · 16x17 · 18x19 · 20x22 · 21x23 · 24x27 · 25x28
· 30x32



620 x 350 mm

Ref 450-002

~~157,50 €~~ 92,65 €

LLAVES DE TUBO HEXAGONAL

8 LLAVES

DE TUBO HEXAGONAL

6x7 · 8x9 · 10x11 · 12x13 · 14x15 · 16x17 · 18x19 · 20x22



430 x 380 mm

Ref 460-002

~~178,03 €~~ 102,10 €

CrV



12 LLAVES

DE TUBO HEXAGONAL

6x7 · 8x9 · 10x11 · 12x13 · 14x15 · 16x17
18x19 · 20x22 · 21x23 · 24x26 · 25x28 · 30x32



520 x 390 mm

Ref 460-004

~~363,46 €~~ 208,46 €

LLAVE DE DOBLE BOCA ESTRELLA ACODADA

8 LLAVES

DOBLE ESTRELLA ACODADA

6x7 · 8x9 · 10x11 · 12x13 · 14x15 · 16x17 · 18x19 · 20x22



390 x 380 mm

Ref 453-002

~~139,57 €~~ 82,10 €

12 LLAVES

DOBLE ESTRELLA ACODADA

6x7 · 8x9 · 10x11 · 12x13 · 14x15 · 16x17
18x19 · 20x22 · 21x23 · 24x27 · 25x28 · 30x32



75° 75°

CrV



620 x 480 mm

Ref 453-003

~~291,37 €~~ 171,40 €

LLAVES FIJAS

COMBINADAS

- Distribución óptima de cargas
- Fijación rápida
- Máximo rendimiento sin desgaste
- Disminución de daños en tuercas y tornillos

- Mayor vida útil de la llave
- Máxima superficie de contacto
- Distribución homogénea del esfuerzo

CrV



Efecto de esfuerzo:

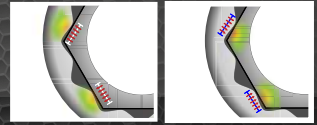

- Sobre la llave
- Sobre la tuerca

8 LLAVES

COMBINADAS

8 · 10 · 11 · 12 · 13 · 14 · 17 · 19

Ref 451-018

~~89,54 €~~ 52,68 €



12 LLAVES

COMBINADAS

8 · 9 · 10 · 11 · 12 · 13 · 14 · 15 · 16 · 17 · 18 · 19

Ref 451-022

~~132,80 €~~ 78,12 €



14 LLAVES

COMBINADAS

8 · 9 · 10 · 11 · 12 · 13 · 14
17 · 19 · 22 · 24 · 27 · 30 · 32

Ref 451-002

~~228,23 €~~ 134,25 €



650 x 440 mm

17 LLAVES

COMBINADAS

6 · 7 · 8 · 9 · 10 · 11 · 12 · 13 · 14 · 15
16 · 17 · 18 · 19 · 20 · 21 · 22

Ref 451-003

~~197,69 €~~ 110,47 €



470 x 450 mm

18 LLAVES

COMBINADAS

8 · 9 · 10 · 11 · 12 · 13 · 14 · 15 · 16
18 · 19 · 22 · 23 · 24 · 26 · 27 · 30 · 32

650 x 480 mm

Ref 451-004

~~296,54 €~~ 174,43 €



24 LLAVES

COMBINADAS

6 · 7 · 8 · 9 · 10 · 11 · 12 · 13 · 14 · 15 · 16 · 17
18 · 19 · 20 · 21 · 22 · 24 · 26 · 27 · 28 · 30 · 32 · 36

650 x 580 mm

Ref 451-005

~~425,68 €~~ 250,40 €

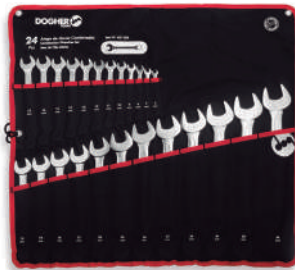

26 LLAVES

COMBINADAS

6 · 7 · 8 · 9 · 10 · 11 · 12 · 13 · 14 · 15 · 16 · 17 · 18 · 19
20 · 21 · 22 · 23 · 24 · 25 · 26 · 27 · 28 · 29 · 30 · 32

650 x 500 mm

Ref 451-006

~~434,35 €~~ 255,50 €



LLAVES COMBINADAS

DE CARRACA REVERSIBLE

CrV

72 (5°)

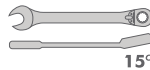

15°



5 LLAVES COMBINADAS

CARRACA REVERSIBLE

8 · 10 · 13 · 17 · 19

Ref 457-014

~~180,521 €~~ 106,18 €



7 LLAVES COMBINADAS

CARRACA REVERSIBLE

10 · 12 · 13 · 14 · 15 · 17 · 19

Ref 457-001

~~255,65 €~~ 146,62 €



330 x 390 mm

8 LLAVES COMBINADAS

CARRACA REVERSIBLE

8 · 10 · 11 · 12
13 · 14 · 17 · 19

Ref 457-018

~~278,48 €~~ 163,82 €



LLAVES COMBINADAS DE CARRACA PLANA SIN REVERSOR



12 LLAVES COMBINADAS

8 · 9 · 10 · 11 · 12 · 13
14 · 15 · 16 · 17 · 18 · 19

▶ Ref 4557-022
~~278,48 €~~ **163,81 €**



LLAVES DE CARRACA COMBINADA FLEXIBLE



5 LLAVES DE CARRACA COMBINADA FLEXIBLE

8 · 10 · 13 · 17 · 19

▶ Ref 458-015
~~170,23 €~~ **97,65 €**



LLAVE DE CARRACA 4 EN 1

Cr-V **72^{LS}**

mm	mm	Ref	Price
10x13	17x19	475-10-19	41,04 € 24,15 €

3 LLAVES DE CARRACA 4 EN 1

8x13: 8x10 12x13
9x15: 9x11 14x15
16x19: 16x17 18x19

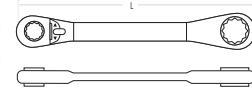

220 x 330 mm

▶ Ref 475-001
~~118,57 €~~ **68,01 €**

LLAVES DE PIPA ABIERTA 6X6



10 LLAVES DE PIPA ABIERTA 6X6

6 · 7 · 8 · 10 · 11 · 12 · 13 · 14 · 17 · 19

▶ Ref 462-011
~~183,27 €~~ **105,10 €**



LLAVES DINAMOMÉTRICAS

LLAVE DINAMOMÉTRICA PROFESIONAL



N°m	mm	L mm	mm	Ref	Price	Price
▶ 1-6	0,05	210	1/4"	625-01-06	241,14 €	141,84 €
2-10	0,1	280	1/4"	625-02-10	256,95 €	151,15 €
10-50	0,25	330	1/4"	625-10-50	268,43 €	157,90 €
10-60	0,5	340	3/8"	626-10-60	283,13 €	166,56 €
20-100	0,5	435	1/2"	627-20-100	310,29 €	182,51 €
40-200	0,5	515	1/2"	627-40-210	317,00 €	186,47 €
80-400	2	615	1/2"	627-70-350	365,16 €	214,79 €
100-600	2,5	1050	3/4"	628-100-500	1.109,41 €	652,59 €
200-1000	5	1250	3/4"	628-200-1000	1.565,41 €	920,82 €
300-1.500	10	1850	1"	629-300-1500	2.779,30 €	1.634,88 €

±3%



LLAVE DINAMOMÉTRICA STANDARD

±4%



N°m	mm	L mm	mm	Ref	Price	Price
▶ 5-25	0,1	280	1/4"	630-05-25	180,93 €	106,43 €
14-203	0,5	450	1/2"	632-14-203	255,55 €	150,32 €
50-350	3	570	1/2"	632-70-350	353,30 €	207,82 €

Se puede apretar tanto en giro a izquierdas como a derechas.

LLAVE DE CARRACA

SUPERPROOF



1/4"	L mm	Ref	
	145	510-006	46,79 € 27,51 €
1/2"	L mm	Ref	
	250	544-006	63,87 € 37,57 €

LLAVE DE CARRACA

Cr-V 72 Carraca de precisión de 72 dientes



510-001/544-001

1/4"	L mm	Ref	
	108	510-002	24,65 € 14,13 €
	145	510-001	30,03 € 17,66 €



510-002/544-002

Serie corta disponible Especial para espacios de difícil acceso

1/2"	L mm	Ref	
	170	544-002	34,69 € 19,90 €
	250	544-001	52,09 € 30,63 €

LLAVES DE VASO JUEGOS DE LLAVES DE VASO



10 LLAVES DE VASO SPLINE

5 • 6 • 7 • 8 • 9 • 10
11 • 12 • 13 • 14



1/4"	Ref 511-051
55,26 €	32,34 € NOVEDAD

11 LLAVES DE VASO SPLINE + LLAVE DE CARRACA

5 • 6 • 7 • 8 • 9 • 10
11 • 12 • 13 • 14



1/4"	72 dientes	Ref 511-061
85,29 €		49,93 € NOVEDAD

10 LLAVES DE VASO SPLINE

9 • 10 • 11 • 12 • 13 • 14 • 15 • 17 • 18 • 19



1/2"	Ref 546-051
84,47 €	49,44 € NOVEDAD

13 LLAVES DE VASO SPLINE LLAVE DE CARRACA Y ALARGADOR

8 • 9 • 10 • 11 • 12 • 13 • 14 • 15 • 17 • 19 • 21



1/2"	72 dientes	125 mm	Ref 546-061
156,59 €			91,65 € NOVEDAD

11 LLAVES DE VASO SPLINE + LLAVE DE CARRACA

9 • 10 • 11 • 12 • 13 • 14 • 15 • 17 • 18 • 19



1/2"	72 dientes	Ref 546-062
136,56 €		79,93 € NOVEDAD



Válidas para tuercas desgastadas al 50%

LLAVES DE VASO

CONJUNTOS DE LLAVES DE VASO

VASOS DE IMPACTO 1/2" ESPECIAL LLANTAS



1/2"



17 · 19 · 21



Ref

▶ 575-001 ~~39,78 €~~ **23,40 €**

8 PIEZAS 3/4"

VASOS IMPACTO SERIE LARGA + ADAPTADOR AMPLIADOR

19 · 22 · 24 · 27 · 30 · 32 · 36

Adaptador Ampliador

3/4" ▶ 1/2" (594-026)

Ref

▶ 579-001 ~~400,82 €~~ **234,60 €** ▶



3/4"

CrMo



17 PIEZAS 1/4"

VASOS HEXAGONALES

4 · 4,5 · 5 · 5,5 · 6 · 7 · 8 · 9
10 · 11 · 12 · 13 · 14

Llave de Carraca 72 dientes

Articulación Universal

Alargador: 50 mm

Destornillador Triple Cuadradillo



Ref

▶ 500-001 ~~96,67 €~~ **55,46 €** ▶ 260 x 167 x 62 mm

CrV

1/4"

34 PIEZAS 1/4"

VASOS HEXAGONALES

4 · 4,5 · 5 · 5,5 · 6 · 7 · 8 · 9 · 10 · 11 · 12 · 13 · 14

1/4" · Puntas de atornillar

4 · 5,5 · 6,5

PH1 · PH2 · PH3

Llave de Carraca 72 dientes

Articulación Universal

Alargador: 50 mm

Alargador Flexible: 145 mm

Destornillador Triple Cuadradillo

Portapuntas Cuadradillo de Arrastre 1/4"

Adaptador Espacios Confinados



Ref

▶ 500-002 ~~138,34 €~~ **79,34 €** ▶ 260 x 167 x 62 mm

T10 · T15 · T20 · T25

HX3 · HX4 · HX5 · HX6

47 PIEZAS 1/4"

VASOS HEXAGONALES

4 · 4,5 · 5 · 5,5 · 6 · 7 · 8 · 9 · 10 · 11 · 12 · 13 · 14
Serie Larga: 8 · 10 · 11 · 13

Vasos con Puntas

T10 · T15 · T20 · T25 · T30 · T40

4 · 5,5 · 6,5

HX3 · HX4 · HX5 · HX6 · HX7 · HX8

PH1 · PH2 · PH3

PZ1 · PZ2 · PZ3

Ref

▶ 500-003 ~~239,83 €~~ **126,97 €** ▶

Llave de Carraca 72 dientes

Articulación Universal

Alargador: 50 y 100 mm

Destornillador

Mango Corredizo en "T"

Llaves Allen 1,5 · 2 · 2,5

260 x 167 x 62 mm



LLAVES DE VASO
CONJUNTOS DE LLAVES DE VASO

16 PIEZAS 3/8"
VASOS HEXAGONALES



- 8 · 9 · 10 · 11 · 12 · 13
- 14 · 15 · 16 · 17 · 18 · 19

Llave de Carraca 72 dientes
Articulación Universal
Alargador: 75 mm
Adaptador Espacios Confinados



Ref
▶ 516-001 ~~123,76 €~~ **65,53 €** ▶ 260 x 167 x 62 mm

34 PIEZAS 3/8"
VASOS HEXAGONALES



- 6 · 8 · 10 · 11 · 12 · 13 · 14 · 15 · 16 · 17 · 18 · 19

- 1/4" · Vasos con Puntas T10 · T15 · T20 · T25 · T27 · T30 · T40
- PH0 · PH1 · PH2 · PH3 HX3 · HX4 · HX5 · HX6

Llave de Carraca 72 dientes
Articulación Universal
Alargadores: 75 y 150 mm
Destornillador
Mango Corredizo en "T"
Adaptador 1/4" - 3/8"



Ref
▶ 516-003 ~~230,08 €~~ **121,81 €** ▶ 260 x 167 x 62 mm

14 PIEZAS 1/2"
VASOS HEXAGONALES



- 10 · 11 · 12 · 13 · 14 · 15
- 16 · 17 · 18 · 19 · 21 · 22

Llave de Carraca 72 dientes
Articulación Universal

Ref
▶ 531-001 ~~123,54 €~~ **70,85 €** ▶ 260 x 167 x 62 mm



41 PIEZAS 1/2"
VASOS HEXAGONALES O BIHEXAGONALES



- 8 · 9 · 10 · 11 · 12 · 13 · 14 · 15 · 16 · 17 · 18 · 19 · 21 · 22 · 24 · 27 · 30 · 32

- 5/16" · Puntas de Atornillar T40 · T45 · T50 · T55 · T60
- PH3 · PH4 HX7 · HX8 · HX10 · HX12
- PZ3 · PZ4 8 · 10 · 12

Llave de Carraca 72 dientes
Articulación Universal
Alargadores: 125 y 250 mm
Portapuntas Cuadrado de Arrastre 5/16"-1/2"
Adaptador Triple Función 3/8" - 1/2"
Adaptador Espacios Confinados

Ref
▶ 531-003 ~~256,59 €~~ **147,18 €**
▶ 530-003 ~~256,59 €~~ **147,18 €** ▶ 385 x 280 x 87 mm



16 PIEZAS 3/4"
VASOS HEXAGONALES

- 19 · 22 · 23 · 24 · 27 · 30 · 32 · 36 · 38 · 41 · 46 · 50

Llave de Carraca 24 dientes 500mm
Alargadores: 200 y 100 mm
Mango Corredizo en "T"

Ref
▶ 549-001 ~~644,32 €~~ **341,10 €** ▶



LLAVES DE VASO

CONJUNTOS DE LLAVES DE VASO

76 PIEZAS 1/4" y 1/2"

VASOS HEXAGONALES



▶ **1/4"** Vasos 4 · 4,5 · 5 · 5,5 · 6 · 7 · 8 · 9 · 10 · 11 · 13

- | | |
|-----------------------------|-----------------------------------|
| 1/4" · Puntas de Atornillar | T10 · T15 · T20 · T25 · T27 · T30 |
| PH0 · PH1 · PH2 · PH3 | HX2 · HX3 · HX4 · HX5 · HX6 · HX7 |
| PZ2 · PZ3 | 3 · 4,5 · 5,5 · 6,5 |

▶ **1/2"** Vasos 10 · 11 · 12 · 13 · 14 · 15 · 16 · 17 · 19 · 21 · 24 · 27 · 30 · 32

- | | |
|------------------------------|-----------------------------|
| 5/16" · Puntas de Atornillar | T40 · T45 · T50 · T55 · T60 |
| PH3 · PH4 | HX8 · HX10 · HX12 |
| PZ3 · PZ4 | 8 · 10 · 12 |

Llave de Carraca 72 dientes 1/4" y 1/2"
 Articulación Universal 1/4" y 1/2"
 Alargadores 1/4" y 1/2": 50 y 100 - 125 y 250 mm
 Destornillador Triple Cuadrado 1/4"
 Portapuntas Cuadrado de Arrastre 1/4" y 1/2"
 1/4" ▶ 1/4" 5/16" ▶ 1/2"
 Adaptador Espacios Confinados 1/4" y 1/2"
 Adaptador Triple Función 1/2"
 3/8" ▶ 1/2"



440 x 305 x 92 mm

Ref

▶ **500-025** ~~364,86 €~~ **193,16 €** ▶

94 PIEZAS 1/4" y 1/2"

VASOS HEXAGONALES



▶ **1/2"** Vasos 10 · 11 · 12 · 13 · 14 · 15 · 16 · 17 · 18 · 19 · 20 · 21 · 22 · 24 · 27 · 30 · 32
 Serie Larga: 14 · 15 · 17 · 19 Bujías: 16 · 21

- | | |
|----------------------------|--------------------------|
| 5/16" Puntas de Atornillar | T40 · T45 · T50 · T55 |
| PH3 · PH4 | HX8 · HX10 · HX12 · HX14 |
| PZ3 · PZ4 | 8 · 10 · 12 |

▶ **1/4"** Vasos 4 · 4,5 · 5 · 5,5 · 6 · 7 · 8 · 9 · 10 · 11 · 12 · 13 · 14
 Serie Larga: 6 · 7 · 8 · 9 · 10 · 11 · 12 · 13

- | | |
|------------------|----------------------------------|
| Vasos con Puntas | T8 · T10 · T15 · T20 · T25 · T30 |
| PH1 · PH2 | HX3 · HX4 · HX5 · HX6 |
| PZ1 · PZ2 | 4 · 5,5 · 7 |

LLAVES DE CARRACA 72 DIENTES 1/4" Y 1/2"
 Articulación Universal 1/4" y 1/2"
 Alargadores: 50 y 100 - 125 y 250 mm 1/4" y 1/2"
 Destornillador 1/4"
 Alargador Flexible 1/4"
 Mango Corredizo en "T" 1/4"
 Portapuntas 5/16" ▶ 1/2"
 Adaptador 3/8" ▶ 1/2"
 Llaves Allen 1,5 · 2 · 2,5



380 x 300 x 84 mm

Ref

▶ **500-030** ~~148,29 €~~ **87,24 €** ▶

108 PIEZAS 1/4" y 1/2"

VASOS HEXAGONALES



▶ **1/4"** 4 · 4,5 · 5 · 5,5 · 6 · 7 · 8 · 9 · 10 · 11 · 12 · 13 · 14
 Serie Larga: 6 · 7 · 8 · 9 · 10 · 11 · 12 · 13

- | | |
|-------------------------|--|
| E4 · E5 · E6 · E7 · E8 | |
| 1/4" · Vasos con Puntas | T8 · T10 · T15 · T20 · T25 · T27 · T30 |
| PH1 · PH2 | HX3 · HX4 · HX5 · HX6 |
| PZ1 · PZ2 | 4 · 5,5 · 6,5 |

▶ **1/2"** 10 · 11 · 12 · 13 · 14 · 15 · 16 · 17 · 18 · 19 · 20 · 21 · 22 · 24 · 27 · 30 · 32
 Serie Larga: 14 · 15 · 17 · 19 · 22 Para Bujías: 16 · 21

- | | |
|---|--------------------------------|
| E10 · E11 · E12 · E14 · E16 · E18 · E20 · E22 | |
| 5/16" · Puntas de Atornillar | T40 · T45 · T50 · T55 · T60 |
| PH3 · PH4 | HX7 · HX8 · HX10 · HX12 · HX14 |
| PZ3 · PZ4 | 8 · 10 · 12 |

Llave de Carraca 72 dientes 1/4" y 1/2"
 Articulación Universal 1/4" y 1/2"
 Alargadores 1/4" y 1/2": 50 y 75 - 125 y 250 mm
 Destornillador 1/4"
 Mango Corredizo en "T" 1/4"
 Adaptador Triple Función 1/2" 3/8" ▶ 1/2"
 Portapuntas Cuadrado de Arrastre 1/2" 5/16" ▶ 1/2"
 Llaves Allen 1,5 · 2 · 2,5



385 x 274 x 88 mm

Ref

▶ **500-026** ~~651,22 €~~ **363,91 €** ▶

LLAVES DE VASO

CONJUNTOS DE LLAVES DE VASO

151 PIEZAS 1/4", 3/8" y 1/2"

VASOS HEXAGONALES



- ▶ 4 · 4,5 · 5 · 5,5 · 6 · 7 · 8 · 9 · 10 · 11 · 12 · 13 · 14
Serie Larga: 4 · 5 · 6 · 7 · 8 · 9 · 10
- ▶ E4 · E5 · E6 · E7 · E8

- Vasos con Puntas T8 · T9 · T10 · T15 · T20 · T25 · T27 · T30
- PH0 · PH1 · PH2 HX3 · HX4 · HX5 · HX6
- PZ0 · PZ1 · PZ2 4 · 5,5 · 6,5 · 7
- TS8 · TS9 · TS10 · TS15 · TS20 · TS25 · TS27 · TS30

- 3 Llaves de Carraca 72 dientes 1/4", 3/8" y 1/2"
- Articulación Universal 1/4", 3/8" y 1/2"
- Alargadores 1/4", 3/8" y 1/2": 50 y 100 - 125 - 125 y 250
- Destornillador 1/4"
- Mango Corredizo en "T" 1/4"
- Adaptador Triple Función 1/2" 3/8" ▶ ◀ 1/2"
- Portapuntas Cuadrado de Arrastre 1/2" y 3/8" 5/16" ▶ ◀ 1/2" / 3/8"
- Llaves Allen 1,27 · 1,5 · 2 · 2,5 · 3 · 4 · 5

- ▶ 10 · 11 · 12 · 13 · 14 · 15 · 16 · 17 · 18 · 19 Para Bujías: 18
Serie Larga: 10 · 11 · 12 · 13 · 14 · 15
- ▶ E10 · E11 · E12 · E14 · E16 · E18

- ▶ 10 · 11 · 12 · 13 · 14 · 15 · 16 · 17 · 18 · 19 · 20 · 21 · 22
24 · 27 · 30 · 32
Serie Larga: 16 · 17 · 18 · 19 · 22 Para Bujías: 16 · 21
- ▶ E20 · E24

- 5/16" Puntas de Atornillar T40 · T45 · T50 · T55 · T60 · T70
- PH3 · PH4 HX7 · HX8 · HX10 · HX12 · HX14
- PZ3 · PZ4 8 · 10 · 12
- TS40 · TS45 · TS50 · TS55 · TS60 · TS70



Ref 500-027 ~~898,64 €~~ **475,75 €** ▶ 435 x 305 x 95 mm

JUEGOS DE LLAVES MACHO

9 LLAVES MACHO

- #### TORX
- T10 · T15 · T20 · T25
T27 · T30 · T40 · T45 · T50

▶ Ref 606-009
~~32,53 €~~ **19,13 €**

▶ Ref 608-009
~~47,83 €~~ **28,13 €**

Serie Extra Larga

9 LLAVES MACHO

- #### TORX SEGURIDAD
- TS10 · TS15 · TS20 · TS25 · TS27 · TS30 · TS40 · TS45 · TS50

▶ Ref 609-009
~~39,50 €~~ **23,24 €**

▶ Ref 611-009
~~55,86 €~~ **32,87 €**

Serie Extra Larga

9 LLAVES MACHO

- #### HEXAGONAL
- 1,5 · 2 · 2,5 · 3
4 · 5 · 6 · 8 · 10 mm

▶ Ref 600-009
~~16,30 €~~ **9,34 €**

▶ Ref 602-009
~~24,58 €~~ **14,46 €**

Serie Extra Larga



9 LLAVES MACHO

- #### HEXAGONAL REDONDAS
- 1,5 · 2 · 2,5 · 3 · 4 · 5 · 6 · 8 · 10 mm

▶ Ref 603-009
~~21,83 €~~ **12,84 €**

Serie Extra Larga



▶ Ref 605-009
~~33,73 €~~ **19,84 €**



▶ Ref 605-069
~~40,70 €~~ **23,94 €**



▶ Ref 607-079
~~31,77 €~~ **18,68 €**

15 LLAVES MACHO

- #### HEXAGONAL REDONDAS
- 1,27 · 1,5 · 2 · 2,5 · 3 · 3,5
4 · 4,5 · 5 · 5,5 · 6 · 7 · 8
9 · 10 mm

▶ Ref 605-089
~~54,72 €~~ **32,19 €**



NIVELES

NIVEL TUBULAR MAGNÉTICO

3 FOLIAS



- 3 Fojas 45° · 90° · 180°
- Imantado



0,5 mm/m



L mm

Ref

▶ 400	783-02-400	22,90 €	13,47 €
600	783-02-600	29,73 €	17,49 €
800	783-02-800	32,58 €	19,16 €
1000	783-02-1000	40,28 €	23,69 €
1200	783-02-1200	51,15 €	30,09 €
1800	783-02-1800	76,50 €	45,00 € ▶

NIVEL TRAPEZOIDAL

2 FOLIAS



0,5 mm/m



L mm

Ref

▶ 400	784-01-400	20,36 €	11,97 €
600	784-01-600	26,45 €	15,54 € ▶

- 2 Fojas 90° · 180°



NIVEL TORPEDO TUBULAR

3 FOLIAS



0,5 mm/m



L mm

Ref

▶ 250	785-001	25,74 €	15,13 € ▶
-------	---------	--------------------	-----------

- 3 Fojas 45° · 90° · 180°
- Protección Antichoque

PINZA AMPERIMÉTRICA

DIGITAL

CAT II 750V ~ 1000A ~ MAX

- Mide voltaje CA y CC, intensidades, continuidad y resistencias.
- Protección frente a sobrecargas.
- Función de bloqueo.
- Continuidad audible.
- Indicador de batería baja.
- Pantalla LCD.
- Incluye puntas de prueba aisladas 10A y funda.
- Requiere pila de 9V.
- IEC 61010
- Grado de Polución II



Ref 795-001

~~46,94 €~~ 27,62 €

MULTÍMETRO

DIGITAL

1000V ~ 750V ~

- Mide voltaje CA y CC, intensidades, continuidad y resistencias.
- Comprueba diodos y transistores NPN y PNP.
- Incluye puntas de prueba aisladas.
- Pantalla LCD.
- Requiere pila 9V (No incluida).
- IEC 61010
- Grado de Polución II



Ref 795-002

~~41,59 €~~ 24,47 €

COMPROBADOR

DE TENSIÓN Y VOLTAJE

3 in 1

CAT II 600V

V ~ 150V · 300V · 500V

900 mm

V ~ 110V · 220V · 380V

- 900 mm de cable
- Diseñado para trabajar en T° entre 5°C - 40°C.
- Altitud hasta 2.000 m.
- IEC 61010
- Grado de Polución II

Ref 795-003

~~17,05 €~~ 10,03 € ▶



FLEXÓMETROS PROFESIONALES

- Cinta métrica metálica
- Botón de bloqueo manual
- Goma de protección antichoque
- Correa de seguridad incluida

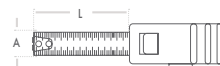

FLEXÓMETRO DOBLE CARA

Class II



· Cinta de doble cara

L m	A mm	Ref	8,88 €	5,22 €
3	16	771-03	13,23 €	7,78 €

FLEXÓMETRO STD

Class II



L m	A mm	Ref	5,39 €	3,16 €
3	16	778-03	7,29 €	4,29 €

CINTA MÉTRICA FIBRA DE VIDRIO



Class III



L m	A mm	Ref	27,32 €	16,07 €
30	13	779-030	31,83 €	18,72 €

CINTA MÉTRICA FIBRA DE VIDRIO



Class III



· Velocidad de recogida de cinta

L m	A mm	Ref	40,38 €	23,75 €
30	15	780-030	55,65 €	32,74 €

Cinta de doble cara

ESCUADRA INOXIDABLE PROFESIONAL

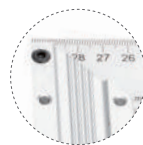

L mm	A mm	B mm	Ref	18,10 €	10,65 €
250	40	1	793-01-250	20,66 €	12,15 €
300	40	1	793-01-300	21,14 €	12,43 €
350	40	1	793-01-350	21,92 €	12,90 €

CALIBRE DIGITAL

0,01 mm



Incluye Manual de Instrucciones
Mide en milímetros y en pulgadas

Inox

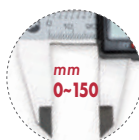

mm	Ref	92,20 €	54,24 €
0 ~ 150	797-150		

PERCUSIÓN

MARTILLOS

MARTILLOS DE BOCAS DE UPE ANTIREBOTE MANGO HICKORY

Ø mm	Ref	36,19 €	21,29 €
35	740-35	47,78 €	28,10 €
50	740-50	63,17 €	37,16 € ▶

UPE



· Compuesto por bocas a presión.

MARTILLOS DE BOCAS DE UPE MANGO HICKORY

Ø mm	Ref	32,57 €	19,16 €
35	7331-35	42,93 €	25,25 €
50	7331-50	56,86 €	33,44 € ▶

UPE



· Compuesto por bocas a presión.

MARTILLOS BOCAS DE PU ANTIREBOTE MANGO METÁLICO

Ø mm	Ref	42,56 €	25,03 €
35	7310-35	58,49 €	34,40 €
50	7310-50	68,70 €	40,41 € ▶

PU



· Compuesto por bocas a presión.

MARTILLO DE PEÑA MANGO FIBRA DE VIDRIO

g	A mm	L mm	Ref	18,36 €	10,79 €
100	18	270	703-100	19,93 €	11,72 €
135	20	265	703-135	21,72 €	12,78 €
320	25	290	703-320	22,89 €	13,47 €
420	30	335	703-420	23,88 €	14,04 € ▶

MARTILLOS DE ENCOFRADOR MANGO FIBRA DE VIDRIO



Imán para ajustar el clavo



g	L mm	Ref	33,45 €	19,68 € ▶
700	500	711-700		



MARTILLOS DE BOLA MANGO HICKORY

	g	A mm	L mm	Ref	17,52 €	10,31 €
B	340	28	320	700-340	21,18 €	12,46 €
C	455	30	360	700-455	24,04 €	14,13 €
D	560	32	350	700-560	26,65 €	15,68 €
E	680	34	375	700-680	28,84 €	16,96 €
F	910	38	405	700-910	32,00 €	18,82 €
G	1130	40	410	700-1130	32,66 €	19,21 € ▶



MARTILLOS DE BOLA MANGO FIBRA DE VIDRIO

	g	A mm	L mm	Ref	28,05 €	16,41 €
B	340	28	310	701-340	29,10 €	17,12 €
C	455	30	305	701-455	31,76 €	18,68 €
D	560	32	315	701-560	34,65 €	20,37 €
E	680	34	340	701-680	40,68 €	23,93 €
F	910	38	370	701-910	47,98 €	28,09 €
G	1130	40	375	701-1130	50,23 €	29,54 € ▶



PERCUSION

MARTILLOS

MAZAS

MANGO FIBRA DE VIDRIO



g	L mm	Ref	Price	Price
▶ 3000	910	713-3000	55,96 €	32,91 €
4000	900	713-4000	70,64 €	41,56 €
5000	900	713-5000	80,10 €	47,12 € ▶

PIQUETA DE ALBAÑIL

MANGO FIBRA DE VIDRIO



g	L mm	Ref	Price	Price
▶ 700	380	715-700	38,12 €	22,41 € ▶

ALCOTANA PALA-PICO

MANGO FIBRA DE VIDRIO



g	L mm	Ref	Price	Price
▶ 400	330	719-400	34,38 €	20,22 €
650	325	719-650	37,08 €	21,81 € ▶

MARTILLO

PARA TECHAR PIZARRA



g	L mm	Ref	Price	Price
▶ 400	315	715-010	20,09 €	11,82 € ▶

CABEZA

DE PICO



g	Ref	Price	Price
▶ 2500	721-2500	32,72 €	19,15 €
3000	721-3000	37,82 €	22,13 € ▶

MACETAS DE ALBAÑIL

MANGO FIBRA DE VIDRIO



g	L mm	Ref	Price	Price
▶ 1000	250	705-1000	28,51 €	16,76 €
1250	250	705-1250	31,72 €	18,66 € ▶

ALCOTANA PALA-HACHA

MANGO FIBRA DE VIDRIO



g	L mm	Ref	Price	Price
▶ 550	385	717-550	30,76 €	18,09 €
650	325	717-650	34,79 €	20,47 € ▶

MAZAS DE GOMA

MANGO HICKORY



g	Ø mm	L mm	Ref	Price	Price
685	60	330	736-685	14,89 €	8,76 €
920	65	340	736-920	18,12 €	10,66 € ▶

PIQUETA DE SOLDADOR

MANGO TUBULAR



g	L mm	Ref	Price	Price
▶ 500	300	715-001	19,37 €	11,40 € ▶

MANGO

MANGO HICKORY PARA PICO



L mm	Ref	Price	Price
▶ 900	722H-900	12,51 €	7,32 € ▶

MANGO

FIBRA DE VIDRIO PARA PICO



L mm	Ref	Price	Price
▶ 900	723H-900	26,30 €	15,40 € ▶

PERCUSION Y CORTE

HACHA

MANGO HICKORY



g	L mm	Ref	26,89 €	15,82 €
▶ 500	450	724-500	29,10 €	17,12 €
1000	675	724-1000	39,62 €	23,31 € ▶

MAZA CUÑA

MANGO FIBRA DE VIDRIO



g	L mm	Ref	81,19 €	47,75 € ▶
▶ 3000	920	726-3000		

CUÑAS



g	Ref	28,23 €	16,60 €
▶ 1000	726-010	30,33 €	17,84 €
2000	726-020	35,03 €	20,60 €
3000	726-030	47,88 €	28,15 € ▶

CORTAVARILLAS

CON CUCHILLAS INTERCAMBIABLES

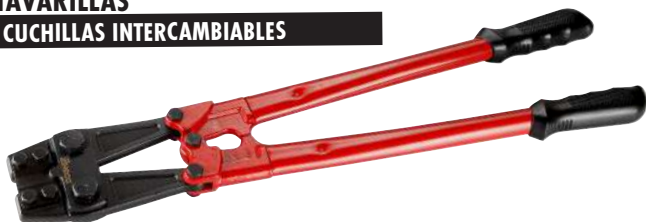

L mm	● mm	Ref	168,59 €	99,16 €
▶ 600	5-10	292-060	204,74 €	120,44 € ▶
900	8-16	292-090		

CUCHILLA TRIANGULAR INTERCAMBIABLE

▶	Ref 292-069R
96,11 €	56,53 €



- Cuchillas triangulares de 3 cortes.
- Fabricadas en acero aleado de alta resistencia.
- Cambio rápido de las cuchillas a través de los tornillos que las fijan a las bocas.
- Brazos de tubo estirados en frío.
- Mangos ergonómicos.

CORTABULONES SERIE PROFESIONAL



L mm	● mm	Ref	45,35 €	26,01 €
▶ 200	0,5~2	292-200	62,29 €	35,72 €
300	1~3,5	292-300	72,44 €	41,54 €
320	2~6,5	292-320	96,65 €	55,43 €
470	4~8	292-470	121,22 €	69,53 €
630	5~11	292-630	165,50 €	94,91 €
750	6~13	292-750	225,84 €	129,51 €
900	8~17	292-900	281,89 €	161,68 € ▶
1050	9~19	292-1050		

ALICATE

DIAGONAL ARTICULADO



Capacidad de Corte

- ▶ Cable plano 3,8 mm
- Cable blando 6 mm



▶	Ref 207-225
50,99 €	29,99 €

64 Hrc

- Articulación con muelle.
- Apertura automática.
- Multiplica la fuerza de corte con menor esfuerzo.

**SACABOCADOS INTERCAMBIABLES
ACERO**

11
Pcs



Ref 940-320

940-03-20 Ø 2-20 mm



~~128,33 €~~ **75,49 €**

940-103 Ø 3
940-104 Ø 4
940-106 Ø 6

940-108 Ø 8
940-110 Ø 10



940-112 Ø 12
940-114 Ø 14
940-116 Ø 16

940-118 Ø 18
940-120 Ø 20



**SACABOCADOS INTERCAMBIABLES
BIMATERIAL**

16
Pcs



Ref 940-330

940-03-30 Ø 2-30 mm



~~257,25 €~~ **151,32 €**

940-103 Ø 3
940-104 Ø 4
940-106 Ø 6

940-108 Ø 8
940-110 Ø 10



940-112 Ø 12
940-114 Ø 14
940-116 Ø 16
940-118 Ø 18
940-120 Ø 20

940-122 Ø 22
940-124 Ø 24
940-126 Ø 26
940-128 Ø 28
940-130 Ø 30



**BOTADORES
CILÍNDRICOS**

**COFRE DE BOTADORES
MANGO OCTOGONAL "TOPGRIP" PATENTADO**

Ø 2 · 3 · 4 · 5 · 6 · 8 mm

Protector TOPGRIP
Norma NFE 71211
DIN 6450C

Ref 7445-001

~~65,04 €~~ **38,25 €**

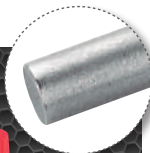

**CAJA DE BOTADORES CILÍNDRICOS
MANGO OCTOGONAL**

6
Pcs

Ø 3 · 4 · 5 · 6 · 8 · 10 mm

Ref 7446-003

~~49,15 €~~ **28,91 €**



**BOTADORES
MANGO "SHOCKGRIP" PATENTADO**

Botadores fabricados para resistir grandes impactos. Su diseño hace que el golpeo se transmita a través del interior del cuerpo, disminuyendo eficazmente el efecto rebote. Gracias al mango patentado SHOCKGRIP, el agarre es más ergonómico y evitamos daños en las manos.

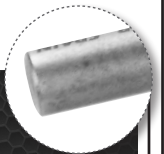

**COFRE DE BOTADORES CILÍNDRICOS
MANGO "SHOCKGRIP" PATENTADO**

5

Pcs Ø 3 · 4 · 5 · 6 · 8 mm

Ref 7447-001

~~88,18 €~~ **51,87 €**



**COFRE DE BOTADORES CILÍNDRICOS
MANGO "SHOCKGRIP" PATENTADO SERIE LARGA**

4

Pcs Ø 10 · 12 · 14 · 16 mm

Ref 7447L-001

~~144,28 €~~ **84,88 €**



**GRANETE
AUTOMÁTICO**

Cr-V 143 mm 36 kgs



Ref 750-013

~~38,45 €~~ **22,62 €**

• Potencia Máxima 36 kgs.

**AGUJA DE TRAZAR
HEXAGONAL GALVANIZADA**



Ref 796-003

• Punta de Carburo de Tungsteno.

~~6,87 €~~ **4,04 €**

ARCO DE SIERRA STD



L mm	Ref	18,23 €	10,72 €
▶ 300	840-004		

- Incluye Hoja Bi-metal.
- Permite instalar hojas de 25 mm de ancho.

ARCO DE SIERRA PROFESIONAL

- Incluye Hoja Bi-metal
- Mango de Aluminio
- Almacén para 10 Hojas
- 45° - 90° · Amarre de la Hoja



L mm	Ref	42,15 €	24,79 €
▶ 300	840-002		

HOJAS DE SIERRA DE MANO BIMÉTALICAS

BI

		BI-METAL HSS EDGE	300 x 13 x 0,65 mm 12" x 1/2 x 0,025 in	Part N° 840-050	840-050
		BI-MET AL HSSCo 8%	300 x 13 x 0,65 mm 12" x 1/2 x 0,025 in	Part N° 840-059	840-059

L mm	A mm	B mm	Z		Ref	240,79 €	141,65 €
300	13	0,65	24	100	840-050		
300	13	0,65	24	100	840-059	356,03 €	209,43 €

JUEGO DE 2 HOJAS DE SIERRA DOBLE CORTE FONTANERÍA



BI	24 Z	CV	Ref	2,83€	1,66 €
			840-070		

JUEGO DE 2 HOJAS DE SIERRA DE MANO BIMÉTALICAS



BI	24 Z	HSS	Ref	6,02 €	3,51 €
			840-067		

SIERRA PROFESIONAL PARA PODA Y PLADUR



- Filo en la punta para corte frontal.
- Apta para Placas de Yeso Laminado.

L mm	Ref	18,78 €	11,04 €
▶ 150	842-001		

SIERRA ABATIBLE MANGO BIMATERIAL

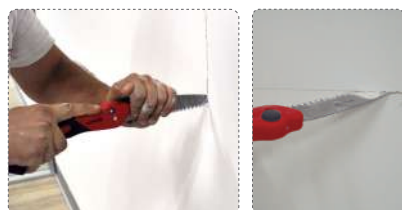

L mm	Ref	26,88 €	15,81 €
▶ 190	843-001		

- Pladur y madera

CUTTER
ULTRA RESISTENTE



- Protección de cuchilla extra larga.
- Mango TPR ergonómico antideslizante.
- Fuerza de bloqueo X5.

A mm	L mm			Ref	15,84 €	9,26 €
25	174	1	0,7	850-251		



CUTTER
MULTIFUNCIÓN AUTORETRÁCTIL

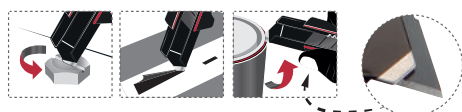
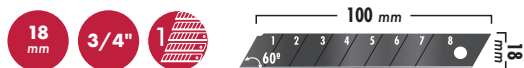

- Protección de cuchilla extra larga.
- Mango ergonómico antideslizante y orificio anticaída.
- Almacén para 2 cuchillas de repuesto.

A mm	L mm			Ref	14,98 €	8,76 €
18	190	1	0,5	850-181		



CUTTER
MULTIFUNCIÓN



- Acero inoxidable en la punta. Máxima durabilidad.
- Doble guía de sujeción de cuchilla.
- Mango ergonómico, bimaternal, soft touch y aluminio.
- Orificio anticaída.

A mm	L mm			Ref	15,71 €	9,19 €
18	160	1	0,5	850-180		

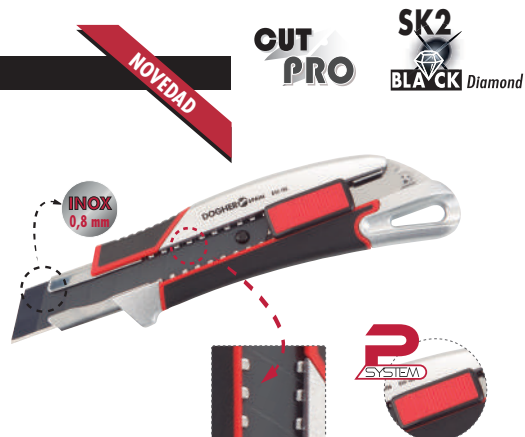

CUTTER SIMPLE
CON TORNILLO DE BLOQUEO

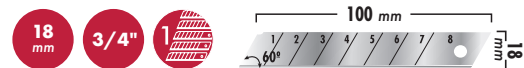

- Almacén para cuchilla de repuesto.

A mm	L mm			Ref	5,68 €	3,34 €
18	160	1	0,5	789-001		



BOLSA INDIVIDUAL DE NYLON
PARA CUTTER

A mm	Ref	11,73 €	6,87 €
18	789V-18		



CUTTER DE SEGURIDAD AUTORETRÁCTIL



- 19 mm
- 3/4"
- 1
- Long Life

• Esquinas redondeadas para mayor seguridad

- Sistema de seguridad con cuchilla autoretractil.
- Acero inoxidable en la punta. Máxima durabilidad.
- Mango soft touch, antideslizante y orificio anticaída.

A mm	L mm		↓	Ref		
19	155	1	0,6	850-005	11,63 €	6,81 €

INOX 1 mm



CUT PRO SK2 Long Life



CUTTER P SYSTEM

- 9 mm
- 3/8"
- 1

- Mango ergonómico bimaternal con orificio anticaída.
- Protección de cuchilla extra larga.

A mm	L mm		↓	Ref		
9	153	1	0,4	850-091	7,72 €	4,51 €



CUT PRO SK2 BLACK Diamond

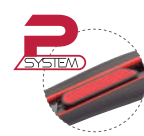

RASCADOR

- 17,5 mm
- 11/16"
- 1
- QUICK CHANGE
- Long Life

CUT PRO SK2



- Protector de cuchilla.
- Mango ergonómico antideslizante.

A mm	L mm		↓	Ref		
17,5	380	1	0,36	887-010	41,95 €	24,56 €

RASQUETA PROFESIONAL

- Cuchilla Carburo.
- Punto giratorio 360°.
- Elimina fácilmente pinturas, colas, barnices u óxidos.
- Punto de apoyo giratorio 360° para maniobrar con diferentes ángulos.
- Mango bi material ergonómico antideslizante.



▶ 60 mm	Ref 887-001	
31,01 €	18,24 €	▶



ESPÁTULA MANGO BIMATERIAL HOJA RÍGIDA

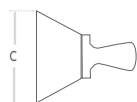

Inox



C mm	Ref		
▶ 152	881-PH2	21,12 €	12,43 € ▶

ESPÁTULA MANGO BIMATERIAL



Inox



C mm	Ref		
▶ 30	879-30	6,11 €	3,59 €
40	879-40	6,16 €	3,62 €
50	879-50	6,46 €	3,79 €
60	879-60	6,75 €	3,97 €
70	879-70	7,22 €	4,24 €
80	879-80	7,74 €	4,56 €
100	879-100	8,64 €	5,09 €
120	879-120	9,93 €	5,84 €
150	879-150	11,91 €	7,00 € ▶

**PALETA MANGO BIMATERIAL
TIPO NORTE**

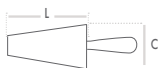

	C mm	L mm	Ref	
▶ A	115	180	883-02-180	15,73 € 9,25 € ▶

**PALETA TIPO MADRID
MANGO BIMATERIAL**



	C mm	L mm	Ref	
▶ F-H	98	178	883-04-180	14,31 € 8,41 € ▶

**PALETA TIPO CATALANA
MANGO BIMATERIAL**



	C mm	L mm	Ref	
▶ B	120	170	883-06-170	15,08 € 8,87 € ▶

**TIRALÍNEAS CON DEPÓSITO
PARA POLVO TRAZADOR**



	m	Ref	
▶ 30	30	798-001	12,79 € 7,53 € ▶



**LLANA RECTANGULAR
MANGO MADERA**

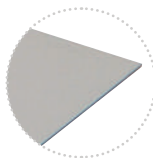

	C mm	L mm	Ref	
▶ 01	150	300	886-002	15,31 € 9,00 € ▶

**ALMENADA
MANGO MADERA**



	C mm	L mm	Ref	
▶ 06	120	280	886-005	16,78 € 9,87 € ▶

**ALMENADA
MANGO MADERA**

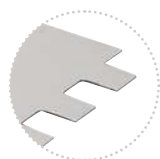

	C mm	L mm	Ref	
▶ 08	120	280	886-006	16,29 € 9,59 € ▶

**ALMENADA
MANGO MADERA**



	C mm	L mm	Ref	
▶ 10	120	280	886-007	17,21 € 10,12 € ▶

**TALOCHA
DE ESPONJA BAJA DENSIDAD**

- Esponja de Baja Densidad.
- Base 30 mm de Espesor.



	C mm	L mm	Ref	
▶ 140	280	886-018	13,68 € 8,04 € ▶	

**TALOCHA
DE PLÁSTICO RECTANGULAR**

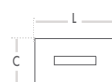

	C mm	L mm	Ref	
▶ 180	270	886-013	7,24 € 4,25 € ▶	

TALOCHA DE GOMA-ESPONJA

- Base 20 mm de Espesor.
- Mango y base fabricados en poliuretano.
- Agujeros esponja de mayor diámetro que 886-017.

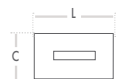
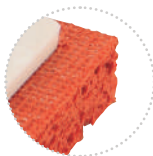

C mm	L mm	Ref		
▶ 140	280	886-016	17,06 €	10,03 € ▶

TALOCHA DE GOMA-ESPONJA DENSA

- Base 20 mm de Espesor.
- Mango y base fabricados en poliuretano.
- Agujeros esponja de menor diámetro que 886-016.

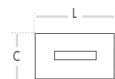
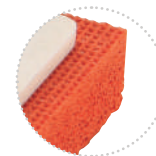

C mm	L mm	Ref		
▶ 140	280	886-017	17,45 €	10,26 € ▶

RAEDERA RECTANGULAR

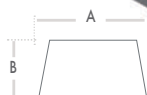

g	A mm	B mm	Ref		
▶ 1400	310	130	876-010	25,64 €	15,09 € ▶

RAEDERA SEMI-CIRCULAR



g	A mm	B mm	Ref		
▶ 1200	270	160	876-020	22,84 €	13,44 € ▶

CABEZA RASTRILLO

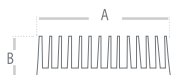

Nº	g	A mm	B mm	Ref		
▶ 12	575	350	95	874-012	13,32 €	7,79 €
14	670	410	95	874-014	14,06 €	8,24 €
16	776	475	95	874-016	14,82 €	8,68 € ▶

MANGO RECTO PARA RASTRILLO



L mm	Ref		
▶ 1200	874-001	11,66 €	6,82 € ▶

BARRA PARA DESENCOFRAR



L mm	mm	Ref		
▶ 300	14	884-04-300	14,59 €	8,57 €
500	20	884-05-500	21,57 €	12,69 €
600	20	884-05-600	27,73 €	16,31 €
700	20	884-05-700	31,52 €	18,54 €
800	22	884-05-800	34,98 €	20,57 €
900	22	884-05-900	40,82 €	24,00 €
1000	22	884-05-1000	45,17 €	26,56 €
1200	22	884-05-1200	50,92 €	29,96 € ▶

VARILLA MEZCLADORA DE LÍQUIDOS



- Gama de varillas para mezclar materiales de baja densidad como pinturas entre otros.
- Conexión a taladros mediante varilla hexagonal.

L mm	Ø mm	Hex	g	Ref		
400	80	7,8	245	890-010	16,17 €	9,47 €
600	100	9,5	500	890-011	17,34 €	10,15 € ▶

VARILLA MEZCLADORA MORTERO



- Gama de varillas para mezclar materiales de alta densidad como morteros entre otros.
- Conexión a mezcladores mediante rosca de M14.

L mm	Ø mm	Hex	g	Ref		
600	100	14	660	890-020	24,76 €	14,49 €
600	120	14	1004	890-022	27,69 €	16,21 €
600	140	14	1110	890-024	31,12 €	18,22 € ▶

**PALAS DE ACERO
MANGO DE MADERA**

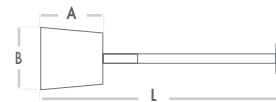

**PALA PUNTA
CON MANGO MULETA**



g	A mm	B mm	L mm	Ref	
2000	340	280	1020	870-010	29,83 € 17,54 €

**PALA CUADRADA
CON MANGO MULETA**



g	A mm	B mm	L mm	Ref	
2000	340	280	1020	870-020	29,83 € 17,54 €

**PALA PUNTA
CON MANGO ANILLA**



g	A mm	B mm	L mm	Ref	
2000	340	280	1020	870-030	33,49 € 19,69 €

**PALA CUADRADA
CON MANGO ANILLA**



g	A mm	B mm	L mm	Ref	
2000	340	280	1020	870-040	34,09 € 20,04 €

**PALAS
CON MANGO ANILLA**

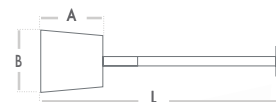

**PALA DE ALUMINIO
CON MANGO ANILLA**



g	A mm	B mm	L mm	Ref	
1500	390	315	1130	871-010	50,35 € 29,62 €

**PALA DE ALUMINIO
CON MANGO ANILLA**



g	A mm	B mm	L mm	Ref	
1000	305	245	1020	871-030	37,54 € 22,07 €

**PALA PVC
CON MANGO ANILLA**



g	A mm	B mm	L mm	Ref	
1600	460	360	1250	871-050	44,34 € 26,07 €

**PALA ACERO FORJADO
CON MANGO ANILLA**



g	A mm	B mm	L mm	Ref	
1800	295	225	1010	870-041	35,23 € 20,72 €

PISTOLAS SELLADORAS

PISTOLA PARA ESPUMA POLIURETANO PRO

- Cuerpo metálico recubierto interior y exteriormente de teflón.
- Mango bimaternal ergonómico.
- Cuerpo de pistola de aluminio con cañón y aguja de acero.
- Adaptador de aluminio para un acoplamiento rápido y firme.
- Tuerca de junta de latón y rueda de regulación de aluminio.
- Fácil de limpiar, uso intensivo.



L mm	L2 mm	Ø mm	Ø2 mm	Ref	
▶ 325	▶ 190	▶ 11	▶ 14	▶ 914-001	41,63 € 24,49 € ▶

PISTOLA SELLADORA

4000
NW 25:1
360°



L mm	Ø mm	Ref	
▶ 225	▶ 55	▶ 917-225	37,13 € 21,74 € ▶



PISTOLA SELLADORA CON RETROCESO RÁPIDO

Ø mm 55 360°
1500
NW



ANTIGOTEO

L mm	Ø mm	Ref	
▶ 225	▶ 55	▶ 916-225	22,28 € 13,10 € ▶

PISTOLA SELLADORA CON CORTE

Ø mm 57 360° 1500
NW



L mm	Ø mm	Ref	
▶ 225	▶ 57	▶ 915-225	24,53 € 14,43 € ▶

PISTOLA SELLADORA TRIPLE PISTÓN

Ø mm 78 1500
NW



L mm	Ø mm	Ref	
▶ 225	▶ 78	▶ 914-225	35,03 € 20,60 € ▶

PISTOLA SELLADORA MANGO DE ALUMINIO

Ø mm 55



L mm	Ø mm	Ref	
▶ 225	▶ 55	▶ 912-225	21,89 € 12,88 € ▶

APLICADOR DE MORTERO CUERPO DE ALUMINIO

Ø mm 50



L mm	Ø mm	Ref	
▶ 375	▶ 50	▶ 913-375	29,58 € 17,40 € ▶

LLAVE DE CARRACA PARA ANDAMIOS

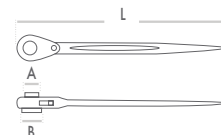

CrV	A mm	B mm	L mm	Ref	
▶	▶ 19	▶ 22	▶ 320	▶ 892-19-22	48,55 € 28,54 € ▶

SARGENTO AUTOMÁTICO LIGERO

REVERSIBLE

16x5 Llanta 120 Kg



L mm	Ref	Price	Price
150	855-150	24,77 €	14,57 €
300	855-300	27,26 €	16,03 €
450	855-450	29,68 €	17,46 €
600	855-600	39,15 €	23,03 €

RODILLERA DESLIZANTE

CON 5 RUEDAS

- Estructura fabricada en Polietileno de gran resistencia.
- 5 Ruedas de 50mm diámetro y 17mm de anchura.
- Protecciones para las rodillas fabricadas en espuma de alta densidad. Incluye:
 - 1 soporte delantero para herramientas.
 - 1 soporte circular central Imantado para herramientas.
- Ideal para talleres de reparación y trabajos sobre pavimentos tales como: limpieza, instalación de parquet, colocación de azulejos, paisajismo, etc...



Ref 075-028
~~94,00 €~~ 55,29 €
 525 x 255 x 90 mm



VENTOSA



Ø mm	Capacidad	Ref	Price	Price
115	50 kg	945-001	19,41 €	11,41 €

- Cuerpo de aluminio con 1 cabezal.
- Uso con una mano.
- Ideal para trabajos en automoción o transporte de productos.
- Usar en superficies lisas no porosas.



Ø mm	Capacidad	Ref	Price	Price
115	100 kg	945-002	38,82 €	22,84 €

- Cuerpo de Aluminio con 2 cabezales.
- Ideal para trabajos en automoción o transporte de productos.
- Usar en superficies lisas no porosas.



Ø mm	Capacidad	Ref	Price	Price
115	130 kg	945-003	53,70 €	31,59 €

- Cuerpo de Aluminio con 3 cabezales.
- Ideal para trabajos en automoción o transporte de productos pesados.
- Usar en superficies lisas no porosas.



Ø mm	Capacidad	Ref	Price	Price
203	180 kg	945-004	102,25 €	60,15 €

- Ventosa de gran resistencia con bomba manual y disco de goma de 203 mm.
- Marca roja de seguridad: aviso de pérdida de succión.
- Válvula de liberación de presión manual.
- Para uso en superficies estructuradas y abombadas.

VENTOSAS PARA LUNAS



Ø mm	Capacidad	Ref	Price	Price
118	80 kg	945-005	46,60 €	27,41 €

- Cuerpo con 2 cabezales.
- Mango articulado, permite flexar adaptándose a las superficies curvadas.
- Especial para el mantenimiento de vehículos, instalación y desinstalación de chapa y de cristal.

Ø mm	Capacidad	Ref	Price	Price
230	200 kg	945-006	176,94 €	104,07 €

- Cuerpo con 1 cabezal.
- Especial para Superficies curvas especialmente lunas.

TIJERAS DE PODA



TIJERA DE PODA HEAVY DUTY



- Cuchilla superior e inferior CK67 con recubrimiento de **Tiaflon**.
- Mango de aluminio y recubrimiento de PVC.
- Cierre de seguridad.

◀ 15	L mm	Ref	
	210	960-003	27,65 € 16,26 € ▶

LIMAS

JUEGO DE 3 LIMAS MANGO BIMATERIAL



200mm	
200mm	
200mm	
Entrefino	

▶	Ref 815-001
	37,66 € 22,15 €



Incluye Funda de Nylon.

LIMA PLANA

PUNTA DE GRANO ENTREFINO MANGO BIMATERIAL

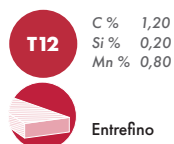

L "	L mm	Ref	
▶ 6	150	803-150	8,31 € 4,88 €
8	200	803-200	10,68 € 6,28 €
10	250	803-250	12,79 € 7,53 €
12	300	803-300	16,07 € 9,46 € ▶

LIMA PLANA

PUNTA DE GRANO BASTO MANGO BIMATERIAL

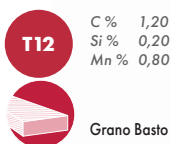

L "	L mm	Ref	
▶ 6	150	803B-150	7,90 € 4,65 €
8	200	803B-200	9,68 € 5,69 €
10	250	803B-250	12,15 € 7,13 €
12	300	803B-300	15,27 € 8,99 € ▶

JUEGO DE 10 LIMAS DE DIAMANTE



x2 140mm		140mm	
x2 140mm		140mm	
140mm		140mm	
140mm		140mm	

▶	Ref 816-001
	138,98 € 81,75 €

LIMA

PARA REPARACIÓN DE ROSCAS

- Para roscas externas e internas
- Pasos métricos: 0,80-1,00-1,25-1,50-1,75-2,00-2,50-3,00



▶	CrV	Ref 817-010
		71,27 € 41,93 €

EXTRACTOR MÚLTIPLE DE 2 Y 3 PATAS

- 100 mm CrV
- 200 mm
- 250 mm

L mm	A min-A max	B min-B max	Ref
▶ 100-250	30-140	55-170	905-004

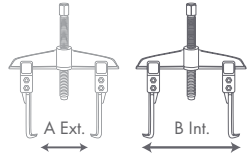

~~458,81 €~~ **269,88 €**

JUEGO DE SEPARADORES DE GUILLOTINA

- CrV
- 30-50 mm
- 50-75 mm

min-max	Ref
▶ 30-75	905-005

~~266,29 €~~ **156,63 €**



REMACHADORAS

REMACHADORA PROFESIONAL



Ref 918-010

~~41,78 €~~ **24,57 €**

- Cabeza con boquilla intercambiable.
- Incluye 4 bocas \varnothing 2,4-3,2-4-4,8 mm.
- Incorpora muelle expulsor de remache.
- Mango ergonómico antideslizante.

REMACHADORA AUTOMÁTICA



4 en 1

Ref 918-012

~~36,42 €~~ **21,43 €**

- Boquilla múltiple.
- 4 Tamaños de remache \varnothing 2,4-3,2-4-4,8 mm.
- Incorpora muelle expulsor de remache.
- Mango ergonómico antideslizante.

REMACHADORA A DOS MANOS

- Mordazas de Metal Duro.
- Multiplicador de Fuerza Interno.
- Mangos Ergonómicos.
- Cuerpo de Aluminio.
- Para Remaches de \varnothing 2,4-3,2-4-4,8-6,4 mm.
- Remaches de Inoxidable: \varnothing 2,4-3,2-4-4,8 mm.

Ref 919-016
~~77,09 €~~ **45,35 €**



XTREME



REMACHADORA MANUAL MULTIFUNCIÓN

3 en 1



- 2,4 3,2 4,0 4,8 6,4 mm
- M3 M4 M5 M6 M8 M10



XTREME



Ref 919-020

~~148,76 €~~ **87,50 €**

REMACHADORA MANUAL PARA TUERCAS



- Especial para trabajos intensivos.
- Remachadora ergonómica para reducir el esfuerzo.
- Fácil reemplazo de los componentes.
- Incluye llave multifuncional.

▶ 410 mm Ref 919-025
~~124,20 €~~ **73,06 €**

LLAVE DE FILTRO CON BANDA METÁLICA



mm	Ref	26,66 €	15,68 €
▶ 65~105	481-65-105		
110~165	481-110-165	28,32 €	16,66 € ▶

• Para cambio de fleje soltar el tornillo de la base giratoria.

LLAVE DE FILTRO FLEXIBLE DE CADENA



L mm (Cadena)	Ø mm	Ref	56,95 €	33,49 €
▶ 350	60-105	481-010		
520	60-160	481-011	84,71 €	49,82 € ▶

LLAVE DE FILTRO DE CINTA



L mm (cinta)	Ø mm	Ref	36,30 €	21,34 €
▶ 580	60-140	481-020		
840	60-265	481-021	67,29 €	39,59 € ▶

30 PIEZAS

JUEGO DE LLAVES DE FILTRO DE CAZOLETAS

Incluye:

- 28 Cazoletas.
- 1 Llave de Filtro de 3 garras Ajustable 65-120 mm.
- 1 Adaptador Reductor de 1/2" a 3/8".

▶ Ref 481-001
~~211,74 €~~ 124,54 €



11 PIEZAS

JUEGO DE ÚTILES PARA INTERIORES

NOVEDAD



- Útiles para facilitar el desmontaje de paneles, salpicaderos, molduras, tableros . y otros accesorios del interior de los automóviles.
- Fabricados en plásticos de alta resistencia para una larga durabilidad.
- Evitan posibles daños en las superficies y piezas más blandas.



▶ Ref 480-011
~~42,26 €~~ 24,74 €

ALICATE SIRGA PARA ABRAZADERAS ELÁSTICAS

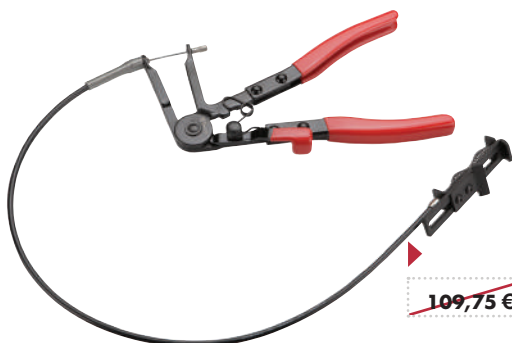

600
mm

Ref 2200-005

~~109,75 €~~

64,56 €

- Longitud del cable 600 mm
- Para abrazaderas de difícil ubicación, provisto de gatillo de retención para dejar abierta la abrazadera permitiendo su fácil colocación o extracción.
- Permite un alcance adicional, la retirada y el bloqueo de las abrazaderas en la posición abierta.
- Para abrazaderas en mangueras de agua, aceite o combustible
- Rango de trabajo: 10-63 mm
- Sistema de bloqueo, liberando las manos y facilitando el trabajo.

ALICATE PARA LATIGUILLOS



L mm

Ref

▶ 155	2200-010	9,97 €	5,85 €
185	2200-011	12,43 €	7,31 €
250	2200-012	16,97 €	9,97 € ▶

- Para estrangular/bloquear latiguillos flexibles.
- Aplicaciones: Líneas de combustible, calefacción, sistema de refrigeración, radiadores, frenos, etc...
- Sistema con mordazas de fácil ajuste con una mano.

ALICATE PARA ABRAZADERAS ELÁSTICAS



215
mm

8,5"



45
mm

Ref 2200-20

~~49,07 €~~

28,87 €

- Las bocas oscilantes están talladas para extraer e instalar abrazaderas elásticas de cualquier tipo en cualquier posición.
- Fabricado en acero aleado para herramientas.
- Apertura máxima: 45 mm
- Mecanismo con 5 posiciones de bloqueo.

ALICATE ACODADO 45° PARA ABRAZADERAS ELÁSTICAS



190
mm

7,5"



Ref 2200-25

~~51,29 €~~

30,18 €

- Alicates para abrir y cerrar abrazaderas reutilizables de tipo CLIC y CLIC-R.
- Mayor accesibilidad gracias a su ángulo de 45°.
- Mayor accesibilidad por su cabezales giratorios.
- Cabeza angulada y mordazas giratorias 360°.
- Mango antideslizante PVC.
- Compatible con:

Volkswagen · Audi · Citroën · Peugeot · Fiat · Mercedes · Opel · Renault

ALICATE PARA ABRAZADERAS ELÁSTICAS



275
mm

10,8"



Ø 12-55
mm

Ref 2200-30

~~129,74 €~~

76,32 €

- Alicates para abrazaderas de auto-sujeción con norma plana y sección de muhr utilizadas en los manguitos de circuitos de refrigeración.
- Las garras talladas en "V" facilitan la instalación de las abrazaderas.
- Apertura máxima: 12-55 mm
- Bloqueo de seguridad.
- Mango PVC.

ALICATE PARA ABRAZADERAS DE TUBOS DE ESCAPE



306 mm

12"



Ref 2200-35

~~67,29 €~~ 39,59 €

- Este alicate nos permite mantener abiertas las abrazaderas con muelle cuando extraemos o instalamos un tubo de escape.
- Apertura máxima: 55 mm
- Fabricado en Acero Aleado para herramientas.
- Mecanismo con 8 posiciones de bloqueo.
- Mango antideslizante PVC.

PINZA PARA EL EQUILIBRADO DE RUEDAS



240 mm

9.1/2"



Ref 2200-40

~~25,24 €~~ 14,84 €

- Pinza para la colocación y extracción de contrapesos de las ruedas.
- Para ensanchar y comprimir los muelles de sujeción.
- Para aflojar, cortar y fijar pesos de equilibrado.
- Con cuchilla para separar los pesos de equilibrado.
- Fabricado en Acero Aleado para herramientas.
- Mango antideslizante PVC.

GATOS DE BOTELLA

GATO DE BOTELLA SOLDADO



• Cierre y apertura de paso



• Zona de apoyo moleteada tratada térmicamente con ajuste de tornillo para mayor versatilidad.



• Zona de bombeo.

HIDRA PRO

• Construido en acero de alta calidad según los standards de calidad y durabilidad.

• La pintura es resistente al aceite, la grasa y la suciedad para una fácil limpieza.



• Palanca telescópica.



Capacidad	Altura mín.	Altura elevación	Altura ajustable	Altura máx.	N.W. kg.	Ref	
▶ 02 TON	168 mm	100 mm	48 mm	316 mm	2 kg	9000-02	55,90 € 32,88 €
05 TON	207 mm	127 mm	60 mm	404 mm	3,7 kg	9000-05	73,70 € 43,35 €
10 TON	222 mm	145 mm	80 mm	447 mm	4,7 kg	9000-10	95,83 € 56,37 € ▶

• Construido en acero de alta calidad según los standards de calidad y durabilidad.

• La pintura es resistente al aceite, la grasa y la suciedad para una fácil limpieza.

• Mango de acero para fácil transporte del gato



• Palanca telescópica.

Capacidad	Altura mín.	Altura elevación	Altura ajustable	Altura máx.	N.W. kg.	Ref	
▶ 15 TON	227 mm	150 mm	80 mm	457 mm	6,9 kg	9000-15	128,99 € 75,87 €
20 TON	225 mm	150 mm	60 mm	445 mm	8,8 kg	9000-20	160,69 € 94,51 €
32 TON	260 mm	160 mm	-	420 mm	17,8 kg	9000-32	243,56 € 143,28 € ▶

GATOS HIDRÁULICOS

DE GARAJE

GATO HIDRÁULICO DE GARAJE

PERFIL BAJO



• Ruedas traseras giratorias para maniobrar fácilmente.



• Diseño de bajo perfil hace fácil alcanzar puntos de elevación bajo la mayoría de los vehículos.



• Ruedas delanteras dobles.

HIDRA PRO



Capacidad	Altura mín.	Altura máx.	N.W. kg.	Dimensiones mm	Ref	
▶ 2 TON	80 mm	510 mm	43 kg	822x360x214	9010-02	787,27 € 463,10 € ▶ CE



• Ruedas giratorias traseras para maniobrar fácilmente.



• Manilla de liberación de seguridad con bloqueo positivo giratorio 360°



• Sillín rotativo 360° para mayor versatilidad

Capacidad	Altura mín.	Altura máx.	N.W. kg.	Dimensiones mm	Ref	
▶ 2 TON	89 mm	359 mm	14,2 kg	556x234x140	9015-02	204,36 € 120,21 € TUV GS CE



• Válvula de seguridad interna

GATO HIDRÁULICO

DE GARAGE



• Ruedas giratorias traseras para maniobrar fácilmente.



• Sillín rotativo 360° para mayor versatilidad

Capacidad	Altura mín.	Altura máx.	N.W. kg.	Dimensiones mm	Ref	
▶ 2 TON	135 mm	340 mm	8,7 kg	447x196x135	9025-02	144,80 € 85,18 € TUV GS CE



• Ruedas de acero de gran resistencia

Capacidad	Altura mín.	Altura máx.	N.W. kg.	Dimensiones mm	Ref	
▶ 3 TON	135 mm	400 mm	16,7 kg	520x195x135	9025-03	215,39 € 126,69 € TUV GS CE

GRÚAS HIDRÁULICAS

DE GARAJE

- Este producto está especialmente diseñado para elevar, bajar y transportar motores, diferenciales, transmisiones y otras cargas pesadas con un mínimo esfuerzo.
- Este producto ha sido probado por su confiabilidad y seguridad.
- Estructura inferior con ruedas para mayor estabilidad y fácil rodadura.
- Brazo elevador ajustable.
- Construcción de acero tubular de gran calibre.
- Se pliega por la mitad para un fácil almacenamiento.



• 4 ruedas giratorias

Capacidad	Altura mín. A	Altura máx. B	Longitud máx. C	Anchura máx. D	N.W. kg.	Ref	
▶ 1 TON	25 mm	2.040 mm	1.510 mm	1.015 mm	65 kg	9030-01	661,89 € 389,35 € ▶ TUV GS CE



• 2 ruedas giratorias

Capacidad	Altura mín. A	Altura máx. B	Longitud máx. C	Anchura máx. D	N.W. kg.	Ref	
▶ 2 TON	25 mm	2.445 mm	1.740 mm	1.040 mm	110 kg	9030-02	1.233,62 € 725,68 € TUV GS CE

GATOS

DE FOSO

- Para trabajos en fosos o bajo vehículos elevados.
- La elevación y el descenso a pedal permiten mantener las manos libres.
- Fácil manejo gracias a sus cuatro ruedas pivotantes y a la gran estabilidad de la base.



• Válvula.



• La amplia base proporciona una gran estabilidad.



• 4 ruedas giratorias 360° de acero de alta resistencia facilitan la movilidad.

Capacidad	Altura mín.	Altura máx.	N.W. kg.	Ref	CE	
▶ 0,5 TON	1.140 mm	1.945 mm	24 kg	9040-0,5	490,41 €	288,47 €



• Válvula



• La elevación y el descenso a pedal permiten mantener las manos libres.



• La amplia base proporciona una gran estabilidad.



• 4 ruedas giratorias 360° de PA de alta resistencia facilitan la movilidad

Capacidad	Altura mín.	Altura máx.	N.W. kg.	Ref	CE	
▶ 1,5 TON	1.130 mm	1.915 mm	24 kg	9040-1,5	1.019,14 €	599,50 €



- Construido en acero de alta calidad y gran resistencia.

- La pintura es resistente al aceite, la grasa y la suciedad.

- El acabado de pintura sin plomo se aplica después de un lavado químico completo para garantizar un acabado duradero y ayudar a prevenir la oxidación.



- Construido en acero de alta calidad y gran resistencia.

- La pintura es resistente al aceite, la grasa y la suciedad.

- El acabado de pintura sin plomo se aplica después de un lavado químico completo para garantizar un acabado duradero y ayudar a prevenir la oxidación.

CABALLETE

DE TALLER

- Caballete para afianzar las cargas como medida de seguridad imprescindible. Gran estabilidad y amplios pies de apoyo.
- El dentado posicionado en ángulo invertido evita un desbloqueo accidental. A más peso mayor seguridad

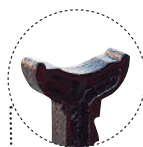

• El área grande de la zona de apoyo proporciona un mejor contacto con la carga.

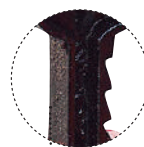

• Dentado de autobloqueo en ángulo invertido para máxima seguridad.



• Sistema patentado de doble bloqueo mediante pasador triangular.

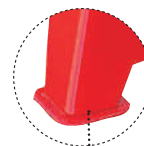

• El gran tamaño de la base impide hundirse en superficies blandas.

- Construido en acero fundido de gran resistencia.

- La pintura es resistente al aceite, la grasa y la suciedad.

- Acero soldado de gran resistencia



Capacidad	Altura mín.	Altura máx.	N.W. kg.	Ref	TUV GS	€/2u.
▶ 2 TON	278 mm	428 mm	5 kg	9050-02	71,40 €	42,00 €
▶ 3 TON	288 mm	428 mm	6,6 kg	9050-03	75,60 €	44,47 €
▶ 6 TON	395 mm	613 mm	12,9 kg	9050-06	166,21 €	97,76 €

Capacidad	Altura mín.	Altura máx.	N.W. kg.	Ref	CE
▶ 10 TON	468 mm	718 mm	27,8 kg	9050-10	277,50 € 163,24 €



Cajones con función bloqueo/desbloqueo y cierre rápido



Cerradura centralizada de seguridad



Ruedas de alta resistencia y frenos de seguridad



Protección de plástico reforzado en los cantos



38 x 38 mm Paneles laterales taladrados



Carga máxima de los Cajones: 40 - 45 Kg

**CARRO
7 CAJONES**



Monza

Ref 025-014
~~1.318,85 €~~ **775,81 €**

**CARRO
6 CAJONES**



Silverstone

Ref 025-015
~~1.277,23 €~~ **751,31 €**

**CARRO
5 CAJONES**



Suzuka

Ref 025-016
~~1.198,97 €~~ **705,28 €**

Dimensiones gama F1

Carro: 678 x 459 x 1.000 mm

Cajones: 568 x 398 x 75 mm · 568 x 398 x 154 mm

**CARRO
7 CAJONES**



Jerez

Ref 025-017
~~1.194,65 €~~ **702,74 €**

**CARRO
6 CAJONES**



Sepang

Ref 025-019
~~1.149,80 €~~ **676,34 €**

Dimensiones gama GP

Carro: 678 x 459 x 1.000 mm

Cajones: 568 x 398 x 75 mm · 568 x 398 x 154 mm



Cajones con función Cierre rápido



Cerradura centralizada de seguridad



Ruedas de alta resistencia y frenos de seguridad



Protección de plástico reforzado en los cantos inferiores

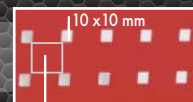

38 x 38 mm Paneles laterales taladrados



Carga máxima de los Cajones: 30 - 35 Kg



Asa lateral metálica para fácil transporte



Cerradura centralizada de seguridad



Ruedas de alta resistencia y frenos de seguridad



Carga máxima de los Cajones: 30 - 35 Kg
Carga Total: 320 Kg

Características de los Carros



CARRO 7 CAJONES



Ref 025-005

~~1.038,36 €~~ 610,79 €

CARRO 6 CAJONES



Ref 025-006

~~930,63 €~~ 547,43 €

CARRO 5 CAJONES



Ref 025-007

~~827,53 €~~ 486,78 €

CARRO 3 CAJONES



680 x 458 x 995 mm

Ref 025-008

~~909,07 €~~ 534,76 €

CARRO 6 CAJONES SF SYSTEM



Sistema Anti Vuelco

NOVEDAD



Ref 025-206

~~957,86 €~~ 560,63 €



SAFETY SYSTEM

- Sistema de seguridad anti vuelco que permite abrir un sólo cajón a la vez.

COMPOSICIÓN +211 HERRAMIENTAS

CARRO +211 HERRAMIENTAS

Silverstone



Ref 025-015

Ref 025-563

~~2.338,51 €~~ 1.375,60 €



CARRO +211 HERRAMIENTAS

Sepang



Ref 025-019

Ref 025-560

~~2.211,08 €~~ 1.300,63 €



CARRO +211 HERRAMIENTAS

std

Ref 025-006

Ref 025-569

~~1.991,90 €~~ 1.171,71 €



205-080 · 330-080 · 451-080 · 450-080



Bandejas combinables 1/4 (375 x 140 x 30 mm) Contenido:

- ▶ Ref 205-080: 4 Alicates Profesionales
- ▶ Ref 330-080: 5 Destornilladores Profesionales
- ▶ Ref 451-080: 8 Llaves Combinadas
- ▶ Ref 450-080: 8 Llaves Doble Boca Abierta

840-080



Bandeja combinable 1 (375 x 560 x 30 mm) Contenido:

- ▶ Ref 840-080: Multiherramienta

500-084

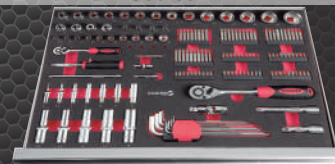

Bandeja combinable 1 (375 x 560 x 30 mm) Contenido:

- ▶ Ref 500-084: Multiherramienta

CARRO METÁLICO
3 BANDEJAS



Ref 025-028
~~301,25 €~~ 177,21 €

CARRO METÁLICO
3 BANDEJAS Y 1 CAJÓN



Incluye cajón
Ref 025-029
~~369,85 €~~ 217,56 €

SERIE
INOX

CARRO METÁLICO
DE 5 Y 7 CAJONES

Inox
Aisi 304

460 mm
846 mm
680 mm



Ref 20025-007
~~2.109,69 €~~ 1.520,22€

• Dim. Cajones
568 x 398 mm

500 mm
998 mm
760 mm



Ref 20025-005
~~2.442,26 €~~ 1.759,87€

• Dim. Cajones
644 x 399 mm

CONJUNTOS
DE HERRAMIENTAS PARA CARROS



MARCAJE DESCRIPTIVO PARA UNA RÁPIDA BÚSQUEDA
ESPUMA DE ALTA DENSIDAD PARA FÁCIL ADAPTACIÓN DE LA HERRAMIENTA

238 HERRAMIENTAS
CONJUNTO DE 6 CAJONES

Ref 025-504
~~3.253,91 €~~ 1.866,22 €

* Carro no incluido

▶ CAJÓN 1

220X-080 • 205-080 • 225-080 • 276-080



▶ CAJÓN 2

300-081 • 330-081 • 351-081 • 360-080



▶ CAJÓN 3

450-080 • 451-080 • 460-080 • 491-080

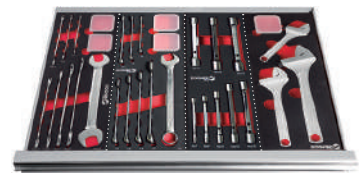

▶ CAJÓN 4

840-080



▶ CAJÓN 5

501-080 • 618-080



▶ CAJÓN 6

534-080 • 538-080 • 502-080 • 503-080



* Consulte el contenido de las bandejas combinables Dogher Tools en las páginas 57 a 63.

4 ALICATES

ALTA POTENCIA



160 mm



200 mm



180 mm



160 mm



Ref 200-080

~~154,28 €~~ **90,76 €**



1

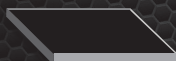

Dimensiones 1:
375 x 560 x 30 mm

1/2



Dimensiones 1/2:
375 x 280 x 30 mm

1/3



Dimensiones 1/3:
375 x 188 x 30 mm

1/4



Dimensiones 1/4:
375 x 140 x 30 mm

BANDEJAS COMBINABLES
PARA CARROS DE TALLER

DOGHER
TOOLS

4 ALICATES

PROFESIONALES



160 mm



160 mm



180 mm



180 mm



Ref 205-080

~~99,29 €~~ **58,40 €**



4 ALICATES

MULTI SEEGER



180 mm



180 mm



180 mm

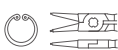

180 mm



Ref 220-080

~~79,53 €~~ **46,78 €**



4 ALICATES

SEEGER PRO



180 mm



180 mm



180 mm



180 mm



Ref 220X-080

~~125,24 €~~ **73,66 €**



3 ALICATES

AISLADOS 1000V



160 mm



160 mm



180 mm



160 mm



Ref 250-080

~~126,71 €~~ **74,53 €**



4 MINI-ALICATES

PROFESIONALES



125 mm



125 mm



125 mm



125 mm



Ref 225-080

~~78,65 €~~ **46,26 €**



4 MINI-ALICATES

ESD



125 mm



125 mm



125 mm



125 mm



Ref 237-080

~~91,65 €~~ **53,90 €**



8 LLAVES

FIJAS



6x7 · 8x9 · 10x11 · 12x13

14x15 · 16x17 · 18x19 · 20x22



Ref 450-080

~~80,05 €~~ **47,09 €**



8 LLAVES

COMBINADAS



8 · 10 · 11 · 12 · 13 · 14 · 17 · 19



Ref 451-080

~~90,54 €~~ **53,26 €**



8 LLAVES

DOBLE BOCA ESTRELLA PLANA



6x7 · 8x9 · 10x11 · 12x13

14x15 · 16x17 · 18x19 · 20x22



Ref 454-080

~~116,63 €~~ **68,60 €**



8 LLAVES

DE TUBO HEXAGONAL



6x7 · 8x9 · 10x11 · 12x13

14x15 · 16x17 · 18x19 · 20x22



Ref 460-080

~~181,03 €~~ **106,49 €**



3 LLAVES AJUSTABLES

DE MOLETA LATERAL



150mm · 200mm · 250mm



Ref 491-080

~~125,50 €~~ **73,82 €**



3 LLAVES AJUSTABLES

PROFESIONALES



150mm · 200mm · 250mm



Ref 493-080

~~94,55 €~~ **55,62 €**



BANDEJAS COMBINABLES PARA CARROS DE TALLER



6 DESTORNILLADORES INDUSTRIAL PLUS

- Recta 3 · 4 · 5 · 6
- PH1 · PH2

Ref 300-080
~~65,26 €~~ **38,38 €**

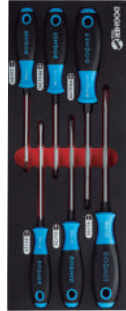

6 DESTORNILLADORES INDUSTRIAL PLUS

- Recta 3 · 4 · 5 · 6
- PZ1 · PZ2

Ref 300-081
~~65,26 €~~ **38,38 €**



6 DESTORNILLADORES INDUSTRIAL PLUS

- T10 · T15 · T20
- T25 · T30 · T40

Ref 303-080
~~59,61 €~~ **35,07 €**



5 DESTORNILLADORES INDUSTRIALES

- Recta 5,5 · 6,5
- PH1 · PH2 · PH3

Ref 315-080
~~53,05 €~~ **31,21 €**



5 DESTORNILLADORES INDUSTRIALES

- Recta 5,5 · 6,5
- PZ1 · PZ2 · PZ3

Ref 315-081
~~51,96 €~~ **30,57 €**



5 DESTORNILLADORES PROFESIONALES

- Plana 5,5 · 6,5
- PH1 · PH2 · PH3

Ref 330-080
~~46,13 €~~ **27,13 €**

- Plana 4 · 5,5
- PH1 · PH2 · PH3

Ref 330-085
~~44,09 €~~ **25,93 €**



5 DESTORNILLADORES PROFESIONALES

- Plana 5,5 · 6,5
- PZ1 · PZ2 · PZ3

Ref 330-081
~~47,88 €~~ **28,16 €**



6 DESTORNILLADORES ANTI-SLIP

- Recta 3 · 4 · 5,5 · 6,5
- PH1 · PH2

Ref 351-080
~~48,90 €~~ **28,76 €**



6 DESTORNILLADORES ANTI-SLIP

- Recta 3 · 4 · 5,5 · 6,5
- PZ1 · PZ2

Ref 351-081
~~50,08 €~~ **29,46 €**



7 DESTORNILLADORES AISLADOS 1000V

- Recta 3 · 4 · 5,5 · 6,5
- PH0 · PH1 · PH2

Ref 360-080
~~76,97 €~~ **45,28 €**



7 DESTORNILLADORES AISLADOS 1000V

- Recta 3 · 4 · 5,5 · 6,5
- PZ0 · PZ1 · PZ2

Ref 360-081
~~77,55 €~~ **45,62 €**



3 TENAZAS GRIP



125mm · 175mm · 250mm

Ref 276-080
~~84,50 €~~ **49,71 €**



2 MARTILLOS

Martillo de Peña 320g
 Ref 702-320

Martillo Boca de Nylon Ø 35
 Ref 742-35

Ref 700-080
~~59,05 €~~ **34,74 €**



26 PIEZAS

VASOS CON PUNTA 1/2"

- 4 · 5 · 6 · 7 · 8 · 10
12 · 14 · 17 · 19
T20 · T25 · T27 · T30
T40 · T45 · T50 · T55 · T60
- 5 · 6 · 8 · 10 · 12 · 14 · 16



Ref 534-080
~~398,47 €~~ **222,68 €**

12 PIEZAS

VASOS CON PUNTA 1/2" SERIE LARGA

- 100 mm: 5 · 6 · 7 · 8 · 12
140 mm: 5 · 10
- 120 mm: T40 · T55
- 100 mm: 8 · 10 · 12



Ref 538-080
~~246,96 €~~ **138,00 €**

18 PIEZAS

VASOS 1/4" 3/8" 1/2" SERIE LARGA

- 4 · 5 · 6 · 7
8 · 9 · 10
- 10 · 11 · 12 · 13 · 14 · 15
- 16 · 17 · 18 · 19 · 22



Ref 502-080
~~231,48 €~~ **129,35 €**

29 PIEZAS

VASOS TORX DE 1/4" Y 1/2"

- E10 · E11 · E12 · E14 · E16
E18 · E20 · E22 · E24
 TS20 · TS25 · TS27 · TS30
TS40 · TS45 · TS50 · TS55 · TS60
- E4 · E5 · E6 · E7 · E8
 T6 · T7 · T8 · T9 · T10 · T15



Ref 503-080
~~316,58 €~~ **176,93 €**

22 PIEZAS

VASOS HEXAGONALES 3/8"

- 6 · 7 · 8 · 9 · 10 · 11 · 12 · 13 · 14
15 · 16 · 17 · 18 · 19 · 20 · 21 · 22

- Llave de Carraca 72 dientes
- Articulación Universal
- Alargadores: 75 y 150 mm
- Mango Corredizo en T



Ref 516-080
~~250,23 €~~ **139,85 €**

46 PIEZAS

VASOS HEXAGONALES O BIHEXAGONALES 1/4"

- 4 · 4,5 · 5 · 5,5 · 6 · 7 · 8 · 9 · 10 · 11 · 12 · 13 · 14
Serie Larga: 6 · 7 · 8 · 9 · 10 · 11 · 12 · 13 · 14
- HX3 · HX4 · HX5 · HX6 · HX7 · HX8
- PH1 · PH2 · PH3 PZ1 · PZ2
- T10 · T15 · T20 · T25 · T30 · T40

- Llave de Carraca 72 dientes
- Articulación Universal
- Alargadores: 50 y 100 mm
- Alargador Flexible 145 mm
- Destornillador
- Mango Corredizo en T



Ref 500-081 ~~407,73 €~~ **227,84 €**
 Ref 501-081 ~~407,73 €~~ **227,84 €**

13 BOTADORES

Y GRANETES

- Ref 7446 3x10 6x10
4x10 8x12
5x10 10x12
- Ref 7449 2,5x7 4x8
3x7 6x10
3,5x8 8x12
- Ref 750-013



Ref 7446-080
~~133,05 €~~ **78,26 €**

3 ORGANIZADORES



Ref 010-080
~~40,53 €~~ **23,84 €**

3 HERRAMIENTAS

PARA ELECTRICISTA

- Tijeras Pelacables con Ranura
Ref. 296-003
- Alicate para Terminales
Ref 296-056
- Pelacables Automático
Ref 296-051



Ref 296-080
~~87,29 €~~ **51,34 €**

4 ALICATES

AISLADOS 1000V

- 240 mm 160 mm
- 160 mm 180 mm



Ref 250-081
~~182,86 €~~ **107,57 €**

4 ALICATES

PROFESIONALES

- 160 mm 250 mm
- 180 mm 160 mm



Ref 205-081
~~121,22 €~~ **71,31 €**

10 DESTORNILLADORES

PROFESIONALES Y AISLADOS 1000V

- Recta
4 · 5,5 · 6,5
- PH1 · PH2
- Plana
4 · 5,5 · 6,5
- PH1 · PH2

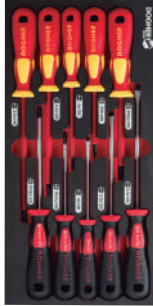

Ref 330-084

~~98,33 €~~ **57,84 €**

7 DESTORNILLADORES

PROFESIONALES

- Plana
3 · 4 · 5,5 · 6,5
- PH0 · PH1 · PH2

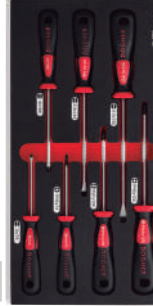

Ref 330-082

~~55,02 €~~ **32,37 €**

7 DESTORNILLADORES

PROFESIONALES

- Plana
3 · 4 · 5,5 · 6,5
- PZ0 · PZ1 · PZ2

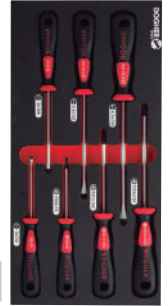

Ref 330-083

~~56,53 €~~ **33,25 €**

10 LLAVES

FIJAS



6x7 · 8x9 · 10x11 · 12x13
14x15 · 16x17 · 18x19
20x22 · 21x23 · 24x26



Ref 450-081

~~115,49 €~~ **67,93 €**

3 LLAVES

FIJAS



25x28 · 27x29 · 30x32



Ref 450-082

~~83,26 €~~ **48,97 €**

10 LLAVES

COMBINADAS



8 · 10 · 11 · 12 · 13
14 · 17 · 19 · 22 · 24



Ref 451-081

~~129,91 €~~ **76,41 €**

11 LLAVES

COMBINADAS

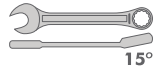

7 · 8 · 10 · 11 · 12 · 13
14 · 17 · 19 · 22 · 24



Ref 451-082

~~136,61 €~~ **80,35 €**

3 LLAVES

COMBINADAS



27 · 30 · 32



Ref 451-083

~~106,67 €~~ **62,75 €**

6 LLAVES

DE ESTRELLA ACODADAS

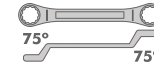

8x9 · 10x11 · 12x13
14x15 · 16x17 · 18x19



Ref 453-080

~~108,86 €~~ **64,03 €**

9 PIEZAS

6 LLAVES DE CARRACA REVERSIBLE
3 CUADRADILLOS DE ARRASTRE

1/4" · 3/8" · 1/2"

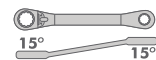

8x9 · 10x11 · 12x13
14x15 · 16x18 · 17x19



Ref 455-080

~~294,32 €~~ **173,13 €**

10 PIEZAS

7 LLAVES COMBINADAS DE CARRACA REVERSIBLES
3 CUADRADILLOS DE ARRASTRE



1/4" · 3/8" · 1/2"

10 · 12 · 13 · 14 · 15 · 17 · 19



Ref 457-080

~~288,92 €~~ **169,96 €**

7 LLAVES COMBINADAS

DE CARRACA REVERSIBLES



8 · 10 · 13 · 15 · 17 · 19 · 22



Ref 457-081

~~268,33 €~~ **157,85 €**

6 LLAVES

DE VASO ARTICULADAS DOBLES



8x9 · 10x11 · 12x13
14x15 · 16x17 · 18x19



Ref 467-080

~~170,31 €~~ **95,18 €**

36 PIEZAS

VASOS HEXAGONALES 1/4"

- Juego de Llaves en Navaja: 1,5 · 2 · 2,5 · 3 · 4 · 5 · 6 · 8
- 5,5 · 6 · 7 · 8 · 9 · 10 · 11 · 12 · 13 Serie Larga: 6 · 8 · 10 · 12 · 13
- PH1 · PH2 · PH3 PZ1 · PZ2 · PZ3
- HX3 · HX4 · HX5 HX6 · HX7 4 · 5,5 · 6,5

- Llave de Carraca 72 dientes
- Articulación Universal
- Alargadores: 50 y 100 mm
- Mango Corredizo en T
- Destornillador
- Adaptador Espacios Confinados

Ref 500-083
~~340,43 €~~ **190,24 €**



27 PIEZAS

VASOS HEXAGONALES O BIHEXAGONALES 1/2"

- 8 · 9 · 10 · 11 · 12 · 13 · 14 · 15 · 16 · 17
- 18 · 19 · 20 · 21 · 22 · 23 · 24 · 27 · 30 · 32
- Para Bujías: 16 · 21

- Llave de Carraca 72 dientes
- Adaptador Triple Función 3/8" · 1/2"
- Alargadores: 125 y 250 mm
- Articulación Universal

Hexagonal Ref 531-080 ~~341,00 €~~ **190,54 €**
 Bi-hexagonal Ref 530-080 ~~341,00 €~~ **190,54 €**



25 PIEZAS

VASOS DE IMPACTO 1/2"

- 8 · 9 · 10 · 11 · 12 · 13 · 14 · 15 · 16
- 17 · 18 · 20 · 21 · 22 · 24
- Serie Larga: 17 · 19 · 21 · 22 · 24
- Vasos Impacto Color: 17 · 19 · 21

- Articulación Universal de Impacto
- Alargador: 125 mm

Ref 570-080
~~416,59 €~~ **245,06 €**



23 PIEZAS

VASOS DE IMPACTO 1/2"

- E10 · E12 · E14 · E16 · E18 · E20 · E24
- T25 · T27 · T30 · T40 · T45 · T50 · T55 · T60
- 5 · 6 · 8 · 10 · 12 · 14 · 17 · 19

Ref 572-080
~~541,34 €~~ **302,53 €**



7 PIEZAS

LLAVE CORREDIZA EN "T" TRES PUNTAS

- 2 · 2,5 · 3 · 4 · 5 · 6 · 8

Ref 623-080
~~180,88 €~~ **106,40 €**

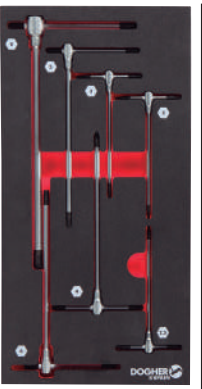

9 PIEZAS

PERCUSIÓN

- Martillo Rivoir Mango Fibra de Vidrio 35 mm
- Botador Cilíndrico 3x10mm
- Botador Cilíndrico 4x10mm
- Botador Cilíndrico 5x10mm
- Botador Cilíndrico 6x10mm
- Botador Cilíndrico 8x12mm
- Botador Cilíndrico 10x12mm
- Martillo de Nylon Mango Fibra de Vidrio 35 mm
- Cortafíos 13x23x30x250 mm

Ref 729-080
~~134,75 €~~ **79,25 €**



8 ALICATES

SEEGER PRO

- 140 / 180 mm 140 / 180 mm
- 140 / 180 mm 140 / 180 mm

Ref 220X-081
~~247,59 €~~ **145,65 €**



11 LLAVES

DE PIPA ABIERTA 6X6

- 8 · 10 · 11 · 12 · 13 · 14
- 15 · 16 · 17 · 18 · 19

Ref 462-080
~~234,61 €~~ **138,00 €**



43 PIEZAS

VASOS DE 1/4" Y 1/2" HEXAGONALES O BIHEXAGONALES

1/2" 10 · 11 · 12 · 13 · 14 · 15 · 16 · 17 · 18 · 19 · 20 · 21
22 · 24 · 27 · 30 · 32 para Bujías: 16 · 21

1/4" 4 · 4,5 · 5 · 5,5 · 6 · 7 · 8
9 · 10 · 11 · 12 · 13 · 14

Llave de Carraca 72 dientes



Llave de Carraca 72 dientes



Adaptador Triple Función



Alargadores: 50 y 100 mm



Alargadores: 125 y 250 mm



Articulación Universal



Articulación Universal



Destornillador



Mango Corredizo en T



Hexagonal Ref 500-080 ~~487,51 €~~ **258,10 €**

Bihexagonal Ref 501-080 ~~487,51 €~~ **258,10 €**



10 LLAVES

EN T HEXAGONALES REDONDAS

2 · 2,5 · 3 · 4 · 5 · 6 · 7 · 8 · 10 · 12

Ref 618-080

~~171,10 €~~ **100,63 €**



10 LLAVES

EN T HEXAGONAL RECTA

2 · 2,5 · 3 · 4 · 5 · 6 · 7 · 8 · 10 · 12

Ref 617-080
~~170,05 €~~ **100,03 €**

10 LLAVES

EN T TORX SEGURIDAD

TS9 · TS10 · TS15 · TS20 · TS25 · TS27 · TS30 · TS40 · TS45 · TS50

Ref 620-080
~~145,67 €~~ **85,69 €**

4 TENAZAS

GRIP

Part N° 275F-010 · 275F-011
275F-012 · 275F-013

Ref 275F-080
~~357,40 €~~ **210,24 €**



3 PERCUSIÓN

Part N° 7310-50 · 700-680 · 7331-35



Ref 700-085
~~147,92 €~~ **87,01 €**

5 ELECTRICISTA

Part N° 795-002 · 296-132 · 296-152
296-060 · 204-200



Ref 795-080
~~215,19 €~~ **126,59 €**

6 ALICATES

AUTOMOCIÓN

Part N° 2200-005 · 2200-010 · 2200-011
2200-012 · 2200-30 · 2200-25



Ref 2200-080
~~360,15 €~~ **211,85 €**

31 PIEZAS

MIXTA

Martillo Nylon Antirrebote Boca presión 35 mm

Martillo de Bola Mango hickory 455 grs.

Flexómetro Magnético de 3 m

Cutter con Tornillo de Bloqueo 18 mm

Lima Plana 200 mm Mango Bimaterial Grano Fino

Lima Plana 200 mm Mango Bimaterial Grano Basto

Tijera de Electricista Profesional 145 mm

Juego de Llaves Macho Hexagonal Redonda XL 9 piezas 1,5-10

10 Hojas Sierra de Mano Bimetálicas 300x13x0,65

Arco de Sierra Profesional Reforzado 300 mm

Botador Cilíndrico 4x10 mm

Botador Cilíndrico 5x10 mm

Botador Cilíndrico 6x10 mm

Tenacilla de Canal Ajustable botón 240 mm

Ref 840-080
~~296,82 €~~ **174,59 €**



155 PIEZAS
MULTIUSO



1/4" Puntas 1/4" · 25 mm

- PH0 · PH1 · PH2 · PH3 · PH4
- HX1,5 · HX2 · HX2,5 · HX3
- PZ0 · PZ1 · PZ2 · PZ3 · PZ4
- HX4 · HX5 · HX6 · HX8 · HX10
- 3 · 3,5 · 4 · 4,5 · 5 · 5,5 · 6 · 6,5 · 8
- R1 · R2 · R3
- T5 · T6 · T7 · T8 · T9 · T10 · T15 · T20 · T25 · T27 · T30 · T40
- TS10 · TS15 · TS20
- TS25 · TS27 · TS30 · TS40

1/4" Puntas 1/4" · 50 mm

- PH1 · PH2 · PH3 · PH4
- HX2 · HX2,5 · HX3
- PZ1 · PZ2 · PZ3 · PZ4
- HX4 · HX5 · HX6 · HX8
- 3 · 3,5 · 4 · 4,5 · 5 · 5,5 · 6 · 6,5 · 8
- R1 · R2 · R3
- T5 · T6 · T7 · T8 · T9 · T10 · T15 · T20 · T25 · T27 · T30 · T40

Ref 500-084
448,45 € 263,79 €

5/16" Puntas 5/16" · 30 mm

T40 · T45 · T50 · T55

1/4"

Llave de Carraca 72 dientes (510-001)

Alargadores 150 mm (509-007)
50 mm (509-006)

Articulación Universal (509-009)

4-4,5-5-5,5-6-7-8-9-10-11-12-13-14

1/2"

Llave de Carraca 72 dientes (544-001)

Alargadores 125 mm (543-003)
75 mm (543-002)

Articulación Universal (543-009)



9 Pcs (605-009) 1,5-2-2,5-3-4-5-6-8-10 mm
Juego de Llaves Macho Hexagonal Redonda Extra Larga

Destornillador

DOGHER (509-017)

Adaptador Mango Hexagonal para Vasos 1/4" · 1/4" (509-019)

Portapuntas cuadradillo arrastre

1/4" · 1/4" (509-012)



4 · 5,5-7-8-10-11-13

Portapuntas Cuadradillo de Arrastre

1/2" · 5/16" (543-018)

Portapuntas Cuadradillo de Arrastre

1/2" · 1/4" (543-028)

8 · 9-10-11-12-13-14-15
16-17-19-22-24-25-27-30



10 · 11-13-17-19

NUEVA GAMA
CONSTRUCCIÓN

Puntales de Expansión

Tornillos de Apriete de Émbolo



- ▶ Tornillos de Apriete-Sargentos.
- ▶ Puntales.

Tornillos de Apriete para Marquetería

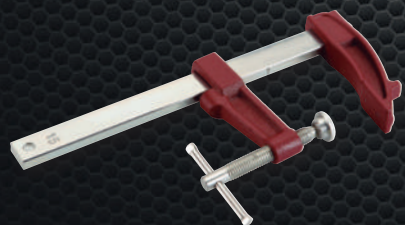

Sargento Automático



Para más información consulte las páginas 454-456 del nuevo catálogo 2023-2024.



PRECIOS RECOMENDADOS - IVA NO INCLUIDO
VÁLIDO PARA PENÍNSULA Y BALEARES

DOGHER TOOLS, S.A.
Polígono Industrial Arriandi
Tabernabarri Nº5 · 48215 Iurreta Vizcaya (Spain)
Tel.: +34 946216145 · Fax: +34 946216147
comercial@dogher.com · export@dogher.com
www.dogher.com

Promoción válida desde el 01/09/2023



**20²³
24**
PROMOCIÓN

PROMO2023

